



**Dear VIZIO Customer,**

Congratulations on your new VIZIO High Definition LCD Television purchase. This User Manual covers both VT420M and VT470M models, for any specific difference between the models please refer to the specification sheets in Chapter 5. Thank you for your support. For maximum benefit of your set, please read these instructions before making any adjustments, and retain them for future reference. We hope you will experience many years of enjoyment from your new VIZIO HDTV.

**For assistance**, please call (877) 668-8462 or visit us at [www.vizio.com](http://www.vizio.com)

To purchase or inquire about accessories and installation services for your VIZIO LCD HDTV, please visit our website at [www.vizio.com](http://www.vizio.com) or call toll free at **(888) 849-4623**.

We recommend you register your VIZIO HDTV either at our website [www.VIZIO.com](http://www.VIZIO.com) or fill in your registration card and mail it in. For peace of mind and to protect your investment beyond the standard warranty, VIZIO offers on-site extended warranty service plans. These plans give additional coverage during the standard warranty period. Visit our website or call us to purchase a plan.

Write down the serial number located on the back of your HDTV.

-----

Purchase Date \_\_\_\_\_

*VIZIO is a registered trademark of VIZIO, Inc. dba V, Inc.  
HDMI logo and "High Definition Multimedia Interface" are registered trademarks of HDMI Licensing LLC.  
Manufactured under license from Dolby Laboratories.  
Dolby and the double-D symbol are trademarks of Dolby Laboratories.*



**SRS**  **SRS**   
**TruSurround HD** and **TruVolume** are trademarks of SRS Labs, Inc.  
*TruSurround HD and TruVolume technologies are incorporated under license from SRS Labs, Inc.*

*THE TRADEMARKS SHOWN HEREIN ARE THE PROPERTY OF THEIR RESPECTIVE OWNERS; IMAGES USED ARE FOR ILLUSTRATION PURPOSES ONLY. BRAVO, VIZIO AND THE V LOGO AND WHERE VISION MEETS VALUE AND OTHER VIZIO TRADEMARKS ARE THE INTELLECTUAL PROPERTY OF VIZIO INC. PRODUCT SPECIFICATIONS ARE SUBJECT TO CHANGE WITHOUT NOTICE OR OBLIGATION. © 2008 VIZIO INC. ALL RIGHTS RESERVED.*



## Important Safety Instructions

Your HDTV is designed and manufactured to operate within defined design limits, and misuse may result in electric shock or fire. To prevent your HDTV from being damaged, the following rules should be observed for the installation, use, and maintenance of your HDTV. Read the following safety instructions before operating your HDTV. Keep these instructions in a safe place for future reference.

- To reduce the risk of electric shock or component damage, switch off the power before connecting other components to your HDTV.
- Unplug the power cord before cleaning your HDTV. A damp cloth is sufficient for cleaning your HDTV. Do not use a liquid or a spray cleaner for cleaning your HDTV. Do not use abrasive cleaners.
- Always use the accessories recommended by the manufacturer to insure compatibility.
- When moving your HDTV from an area of low temperature to an area of high temperature, condensation may form in the housing. Wait before turning on your HDTV to avoid causing fire, electric shock, or component damage.
- Use only with the cart, stand, tripod, bracket, or table specified by manufacturer or sold with your HDTV. When a cart is used, use caution when moving the cart/HDTV combination to avoid injury from tip-over. Do not place your HDTV on an unstable cart, stand, or table. If your HDTV falls, it can injure a person and cause serious damage to your HDTV. Use only a cart or stand recommended by the manufacturer or sold with your HDTV.
- A distance of at least 3 feet should be maintained between your HDTV and any heat source, such as a radiator, heater, oven, amplifier etc. Do not install your HDTV close to smoke. Operating your HDTV close to smoke or moisture may cause fire or electric shock.
- Slots and openings in the back and bottom of the cabinet are provided for ventilation. To ensure reliable operation of your HDTV and to protect it from overheating, be sure these openings are not blocked or covered. Do not place your HDTV in a bookcase or cabinet unless proper ventilation is provided.
- Never push any object into the slots and openings on your HDTV cabinet. Do not place any objects on the top of your HDTV. Doing so could short circuit parts causing a fire or electric shock. Never spill liquids on your HDTV.
- Your HDTV should be operated only from the type of power source indicated on the label. If you are not sure of the type of power supplied to your home, consult your dealer or local power company.
- Do not apply pressure or throw objects at your HDTV. This may compromise the integrity of the display. The manufacturer's warranty does not cover user abuse or improper installations.
- The power cord must be replaced when using different voltage than the voltage specified. For more information, contact your dealer.
- Your HDTV is equipped with a **three-pronged grounded plug (a plug with a third grounding pin)**. This plug will fit only into a grounded power outlet. This is a safety feature. If your outlet does not accommodate the three-pronged, have an electrician install the correct outlet, or use an adapter to ground your HDTV safely. **Do not defeat the safety purpose of the grounded plug.**
- When connected to a power outlet, power is always flowing into your HDTV. To totally disconnect power, unplug the power cord.



- The lightning flash with arrowhead symbol within an equilateral triangle is intended to alert the user to the presence of un-isolated, dangerous voltage within the inside of your HDTV that may be of sufficient magnitude to constitute a risk of electric shock to persons.



- The exclamation point within an equilateral triangle is intended to alert the user to



the presence of important operating and servicing instructions in the literature accompanying your HDTV.

- Do not overload power strips and extension cords. Overloading can result in fire or electric shock.
- The wall socket should be installed near your HDTV and easily accessible.
- Only power of the marked voltage can be used for your HDTV. Any other voltage than the specified voltage may cause fire or electric shock
- Do not touch the power cord during lightning. To avoid electric shock, avoid handling the power cord during electrical storms.
- Unplug your HDTV during a lightning storm or when it will not be used for long period of time. This will protect your HDTV from damage due to power surges.
- Do not attempt to repair or service your HDTV yourself. Opening or removing the back cover may expose you to high voltages, electric shock, and other hazards. If repair is required, contact your dealer and refer all servicing to qualified service personnel.
- Keep your HDTV away from moisture. Do not expose your HDTV to rain or moisture. If water penetrates into your HDTV, unplug the power cord and contact your dealer. Continuous use in this case may result in fire or electric shock.
- Do not use your HDTV if any abnormality occurs. If any smoke or odor becomes apparent, unplug the power cord and contact your dealer immediately. Do not try to repair your HDTV yourself.
- Avoid using dropped or damaged appliances. If your HDTV is dropped and the housing is damaged, the internal components may function abnormally. Unplug the power cord immediately and contact your dealer for repair. Continued use of your HDTV may cause fire or electric shock.
- Do not install your HDTV in an area with heavy dust or high humidity. Operating your HDTV in environments with heavy dust or high humidity may cause fire or electric shock.
- Follow instructions for moving your HDTV. Ensure that the power cord and any other cables are unplugged before moving your HDTV.
- When unplugging your HDTV, hold the power plug, not the cord. Pulling on the power cord may damage the wires inside the cord and cause fire or electric shock. When your HDTV will not be used for an extended period of time, unplug the power cord.
- To reduce risk of electric shock, do not touch the connector with wet hands.
- Insert batteries in accordance with instructions. Incorrect polarities may cause the batteries to leak which can damage the remote control or injure the operator.
- If any of the following occurs, contact the dealer:
  - The power cord fails or frays.
  - Liquid sprays or any object drops into your HDTV.
  - Your HDTV is exposed to rain or other moisture.
  - Your HDTV is dropped or damaged in any way.
  - The performance of your HDTV changes substantially.



## Television Antenna Connection Protection External Television Antenna Grounding

If an outside antenna/satellite dish or cable system is to be connected to the TV, make sure that the antenna or cable system is electrically grounded to provide some protection against voltage surges and static charges.

Article 810 of the National Electrical Code, ANSI/NFPA 70, provides information with regard to proper grounding of the mast and supporting structure, grounding of the lead-in wire to an antenna discharge unit, size of the grounding conductors, location of antenna discharge unit, connection to grounding electrodes, and requirements of the grounding electrode.

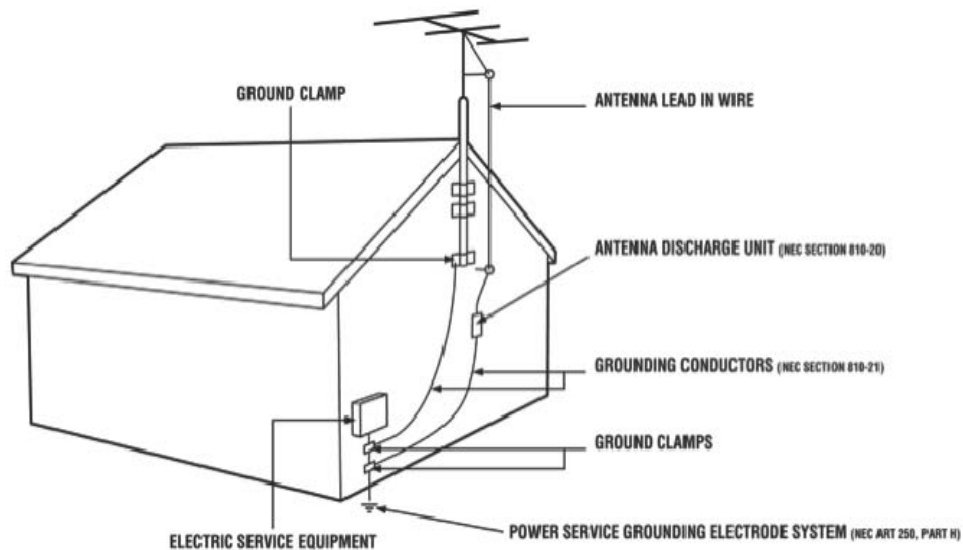

### Lightning Protection

For added protection of the TV during a lightning storm or when it is left unattended or unused for long periods of time, unplug the TV from the wall outlet and disconnect the antenna or cable system.

### Power Lines

Do not locate the antenna near overhead light or power circuits, or where it could fall into such power lines or circuits.

**Remember, the screen of the coaxial cable is intended to be connected to earth in the building installation.**



## FCC Bulletin for New TV Owners

The nationwide switch to digital television broadcasting will be complete on June 12, 2009, but your local television stations may switch sooner. After the switch, analog-only television sets that receive TV programming through an antenna will need a converter box to continue to receive over-the-air TV. Watch your local stations to find out when they will turn off their analog signal and switch to digital-only broadcasting. Analog-only TVs should continue to work as before to receive low power, Class A or translator television stations and with cable and satellite TV services, gaming consoles, VCRs, DVD players, and similar products.

For additional information, please contact the parties listed below, as appropriate:

**FCC (US Federal Communications Commission)**

<http://www.fcc.gov/>

Phone: 1-888-CALL-FCC (1-888-225-5322)

TTY: 1-888-TELL-FCC (1-888-835-5322)

Fax: 1-866-418-0232

E-mail: [fccinfo@fcc.gov](mailto:fccinfo@fcc.gov)

**NTIA (National Telecommunications and Information Administration)**

<http://www.ntia.doc.gov/>

1-888-DTV-2009

**Listings of US Television Stations**

<http://www.high-techproductions.com/usTVstations.htm>

Your VIZIO HDTV is capable of receiving Digital Broadcasts, and no Digital Converter Box is required.



## Opening the Package

Your VIZIO HDTV and accessories are carefully packed in a cardboard carton that has been designed to protect it from transportation damage. Now you have opened the carton check that your HDTV is in good condition and that all of the accessories are included.

The HDTV weighs approximately 45lbs and about 41" wide x 28" tall (VT420M); and 53lbs and about 45"wide x 31" tall (VT470M), we strongly advise that you have at least 2 people to unpack and install the HDTV.

The screen can easily be scratched or broken so please handle the product gently and never place the HDTV with the glass facing downwards on a surface without protective padding.

**IMPORTANT:** Save the carton and packing material for future shipping.

## Package Contents

VIZIO VT420M or VT470M

Detachable Stand Base

4 Thumbscrews (to attach Stand)

VIZIO Remote Control VR4

Power Cord

Screen Cleaning Cloth

This User Manual

Quick Setup Guide

Registration Card

2 AA Batteries for the Remote Control



## TV Setup and Stand Assembly

**Note:** We strongly recommend that two people perform the setup and assembly due to the weight and size of the TV.

### To unpack the TV and stand base:

1. Remove the remote control, batteries, and power cord from the foam end caps.
2. Remove the two top foam end caps.
3. Remove the stand base under foam end cap.
4. Remove the TV from the box and lay it face down on a clean, flat surface.

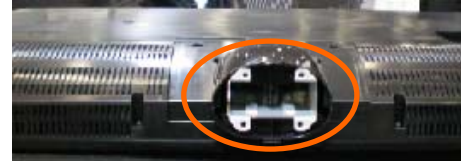

**Note:** Make sure that the surface is free of debris to prevent the TV screen from getting scratched.

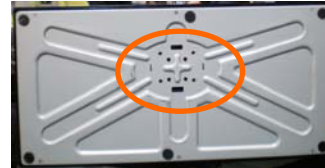

### To attach the TV stand base:

1. Line up the stand neck (attached to the TV) with the stand base.
2. Push the stand base onto the stand neck.
3. On the bottom of the base, insert the included (Qty. 4) thumbscrews and tighten it.
4. Move the TV into an upright position.



**Caution:** Do not apply pressure to the screen or throw objects at your HDTV. This may compromise the integrity of the display. The manufacturer's warranty does not cover user abuse or improper installations.



## Additional certified accessories sold separately

Wall Mounts

High Definition Cables

Extra or replacement Remote

VIZIO also offers Installation Services and Extended Warranty Services for your VIZIO HDTV.

To purchase or inquire about additional accessories and services for your VIZIO product, visit our web site at [www.VIZIO.com](http://www.VIZIO.com) or call us toll free at 888-VIZIOCE (888-849-4623).

## Installation Preparation

Please read this user manual carefully before installing your VIZIO HDTV.

The power consumption of the TV is about 176W (AVG) and 215W (AVG) for the VT420M and VT470M; respectively, please use the power cord designated for TV. When an extension cord is required, use one with the correct power rating. The cord must be grounded and the grounding feature must not be defeated.

The TV should be installed on a flat surface to avoid tipping. For proper ventilation, you must allow space between the back of the TV and the wall. If you would like to mount your TV on the wall, please see below 'Preparing Your LCD HDTV for Wall Mounting' for additional information. Avoid installing the TV in places with high humidity, dust or smoke so as not to shorten the service life of the electronic components.

Install the TV in landscape orientation; any 90° clockwise or counter-clockwise installation may induce poor ventilation and excessive component damage.

The HDTV can either be kept on the stand base or mounted on the wall for viewing. If you choose to mount your HDTV on the wall, please refer to "Preparing your LCD HDTV for Wall Mounting" on page 7.

VIZIO offers professional installation services. Please contact VIZIO for more information on these services at 888-VIZIOCE (888-849-4623) or [www.VIZIO.com](http://www.VIZIO.com).





## Preparing your LCD HDTV for Wall Mounting

Your VIZIO HDTV can either be kept on the stand base or mounted on the wall for viewing. If you choose to mount the TV on the wall, please follow the instructions below for removing the stand.

### To remove the stand:

5. Unplug all cables from the HDTV.
6. Place your HDTV face down on a soft and flat surface (blanket, foam, cloth, etc) to prevent any damage to the TV.
7. Remove the total of eight (4) screws holding the stand to the TV. M4, 12mm long
8. Carefully remove the stand, pulling the base towards you.

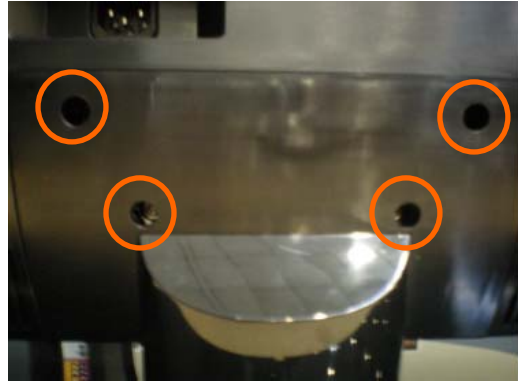

The TV can fit securely to a mount (sold separately) by utilizing the mounting holes in the center of the back panel of the TV. Please make sure to read the instructions of your specific mount to properly hang your TV.

The pitch of the mounting holes is 400mm horizontally and 200mm vertically.

The screw type required is metric M6, 12mm pitch. The length of the screws will depend on the thickness plate being attached to the TV.



To find the perfect mount for your HDTV, browse VIZIO's certified mount selection at [www.VIZIO.com](http://www.VIZIO.com) or call directly 888-VIZIOCE (888-849-4623).



## Table of Contents

Important Safety Instructions.....	2
<b>Chapter 1 Basic Controls and Connections .....</b>	<b>11</b>
Front Panel.....	11
Side Panel Controls.....	11
Rear and Side Panel Connections .....	12
VIZIO Universal Remote Control.....	14
Remote Control Range.....	15
VIZIO Remote Control Precautions .....	15
Inserting the remote control batteries .....	15
Using a Cable or Satellite Remote.....	15
<b>Chapter 2 Connecting Equipment .....</b>	<b>16</b>
Connecting Your Cable or Satellite Box .....	17
Using HDMI .....	17
Using Component Video.....	19
Connecting Coaxial (RF).....	20
Using Your Antenna or Digital Cable for DTV.....	20
Using Your Antenna or Cable for TV .....	21
Using the Antenna or Cable through your VCR.....	21
Connecting Your DVD Player.....	22
Using HDMI .....	22
Using Component Video.....	24
Using S-Video (AV) .....	25
Using Composite (AV) Video .....	26
Connecting Your VCR or Video Camera.....	27
<b>Connecting a USB (FAT32 Format) Storage Device.....</b>	<b>27</b>
Connecting an external Receiver/Amp.....	28
Connecting a PC (Computer).....	29
Preset PC Resolutions .....	30
<b>Chapter 3 Setting Up to Watch Television .....</b>	<b>31</b>
Basic LCD HDTV Start Up .....	31
<b>Selecting Inputs .....</b>	<b>33</b>
<b>Using the INFO Guide .....</b>	<b>34</b>
Displaying the Information Guide Banner.....	34
Watching a TV Program .....	35
Using the On-Screen Display (OSD).....	35
Using the Navigation Wheel.....	36
Unique TV Features .....	37
Adjusting Settings .....	39
Adjusting Multimedia Settings .....	39
Adjusting the Picture .....	41
Adjusting the Picture Settings .....	42
Adjusting the Audio Settings .....	43
Adjusting the Parental Control settings .....	44
Adjusting the Settings.....	48
PIP (Picture-in-Picture).....	49
Understanding Viewing Modes.....	50
<b>Chapter 4 Maintenance and Troubleshooting .....</b>	<b>51</b>
Maintenance.....	51
Troubleshooting Guide .....	51
Telephone & Technical Support .....	53
Compliance .....	54
FCC Class B Radio Interference Statement.....	54
<b>Chapter 5 Miscellaneous Information .....</b>	<b>55</b>
Specifications for VT420M .....	55
Specifications for VT470M .....	56
Glossary – Standard Definitions .....	57
Index .....	61



## Chapter 1 Basic Controls and Connections

### Front Panel

**POWER 'VIZIO' LIGHT**– The VIZIO name lights white when powered on and it will get dimmer when powered off.

**REMOTE CONTROL SENSOR** – This is the window through which all of the remote control signals pass to the sensor. Point the remote control directly at this window for the best response to the remote signal.



### Side Panel Controls

**POWER (⏻)** – Power the TV on by pressing this button once. Press the button again to power the TV off.

**MENU** – This button activates the On Screen Display (OSD). If a sub-menu is active, pressing this button will return to the previous menu level.

**CH ▲▼** – Use these buttons to step up or down the TV channels. While the OSD is active, these buttons function as up and down controls in the OSD menus.

**VOL ◀▶** – Use these buttons to increase or decrease to the speaker volume. While the OSD is active, these buttons function as left and right controls in the OSD menus.

**INPUT (ENTER)** – Repeated pressing of this button steps through the input sources in the following sequence: DTV/TV, AV(S-Video), Comp1, Comp2, HDMI1, HDMI2, HDMI3, HDMI-Side, RGB, Photos and Music. Once you have stepped through the entire sequence, you will return to the beginning of the sequence.

Additionally, when the OSD is active, this button confirms the menu function to be adjusted. When the OSD is not active, this button will show the current input selections.



## Rear and Side Panel Connections

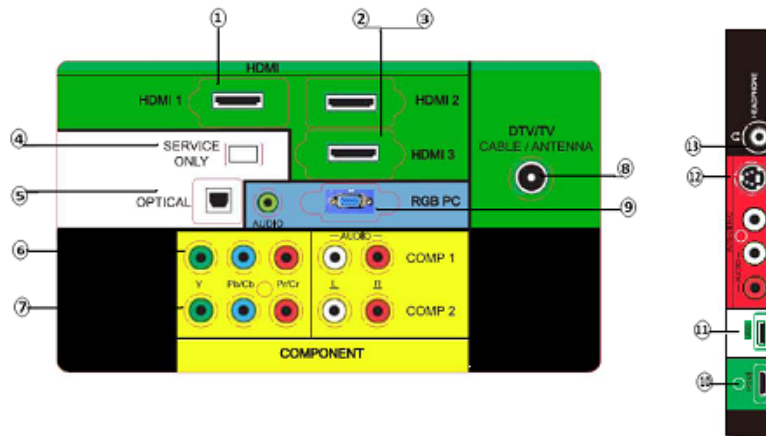

No.	Connection	Rear Panel Color Code	Description
1	<b>HDMI 1</b>	Green	Connect the primary source for digital video such as a DVD multimedia player or set-top box.
2	<b>HDMI 2</b>	Green	Connect a secondary source for digital video such as a DVD multimedia player or set-top box.
3	<b>HDMI 3</b>	Green	Connect an extra audio/video source for digital video such as a DVD multimedia player or set-top box.
4	<b>SERVICE ONLY</b>	White	For factory service only. Use of this input for any purpose other than factory authorized service will void the manufacturer's warranty of this equipment.
5	<b>OPTICAL OUT</b>	White	Connect an SPDIF Optical cable from your HDTV to your home theater system to play digital audio through your home speakers.
6	<b>COMP 1</b> (YPb/CbPr/Cr with Audio L/R)	Yellow	Connect your primary source component (like a DVD Player or set top box) here. From left to right, use green for Y, blue for Pb (or Cb), and red for Pr (or Cr) inputs. Use white for left audio and red for right audio.
7	<b>COMP 2</b> (YPb/CbPr/Cr with Audio L/R)	Yellow	Connect your secondary source (like a DVD Player or set top box) here. From left to right, use green for Y, blue for Pb (or Cb), and red for Pr (or Cr) inputs. Use white for left audio and red for right audio.
8	<b>DTV/TV</b> (Cable/Antenna)	Green	Connect to an antenna or digital cable for digital TV. For digital TV stations in your area visit <a href="http://www.antennaweb.org">www.antennaweb.org</a> .
9	<b>RGB PC /PC</b> <b>Audio</b>	Blue	Connect the video from a computer here. Connect the audio (1/8 in. mini plug stereo connector) from a computer here.



10	<b>HDMI</b>	Green	Connect an extra audio/video source for digital video such as a DVD multimedia player or set-top box.
11	<b>USB</b>	White	Connect a storage source (format FAT32) for MP3 and JPEG files (like a hard drive or thumb drive or card reader). It is recommended to back up your important document files as a precaution to prevent lost of data.
12	<b>AV/S-Video</b>	Red	Connect a source for composite (like a VCR or video game). Use the white and red connectors to connect the external audio from the same source. The S-Video, if connected will take priority over the video of the RCA connector. The audio connectors (white and red) need to be connected in order to hear the program.
13	<b>HEADPHONE</b>	Black	Connecting a headset to this output allows to privately hearing the sound of the program being watched without disturbing other people around in the room.

Certified HDMI and HDMI-DVI cables are available for purchase from [www.VIZIO.com](http://www.VIZIO.com) or by calling 888-VIZIOCE (888-849-4623)



## VIZIO Universal Remote Control

The VIZIO Remote Control is used to control the operation and navigate the OSD menu of this TV. The remote button functions are explained on the following pages.

 **INFO** – This button turns the image and system information on or off.

 **POWER** – Press to turn your HDTV ON. Press it again to turn it OFF.

**TV** – Press to select TV.

**AV** – Press to select the Audio Video input.

Note: If the S-Video cable is being used, the AV will show the signal going through this input because the S-Video takes priority.

**COMP** – Press to select Component (YPbPr) input. Press repeatedly to go through the Component (1 & 2) inputs.

**HDMI** – Press to select HDMI input. Press repeatedly to go through the HDMI (1, 2, 3 and HDMI-Side) inputs.

**MENU/SELECT** – Press to launch the On-Screen Display (OSD) menu. When navigating the OSD, this button is used to select your chosen option.

**Arrow Buttons** (▼ ▲ ◀ ▶) – After pressing **MENU/SELECT**, use arrow buttons to navigate through the OSDs and adjust options, then press **MENU/SELECT** to select your chosen option. When in Pause Live TV mode, left (◀) and right (▶) can be used to rewind and fast forward the recorded segment of the program being watched.

**VOL** (▲ or ▼) – Press to increase or decrease the speaker volume.

**CH** (▲ or ▼) – Press to step up or down through the TV channels.

**MUTE** – Press to turn the sound on and off.

**LAST** – Press to recall the previously viewed channel.

**NUMBER PAD** – Press to select a channel or enter a password.

**INPUT** – Press repeatedly to cycle through the video inputs.

– **(Dash)** – In DTV mode (antenna), use this button to access digital sub-channels. For example, to select 28-2, press 2, press 8, press the dash, and then press 2.

 **PIP** – This button is used to select PIP (Picture-in-Picture) mode.

 **SWAP** – This button is used to swap between inputs while in PIP/POP mode.

 **EXIT** – This button exits the On-Screen Display (OSD) menus.

 **PAUSE** – Pressing this button will start the Pause Live TV feature. When in Pause Live TV mode this button pauses the playback.

▶ **PLAY** – When in Pause Live TV mode, using this button will start playing the recorded programming.

□ **STOP** – Pressing this button will take you out of the Pause Live TV feature to live TV.



## Remote Control Range

- The effective range of the remote control is approximately 30 feet (10 meters) from the front of the receiver window and 13 feet (4 meters) when 30° to the left and right, 20° up and down.
- Point the remote control at the remote control sensor on the front of your HDTV to send commands.
- Do not place any obstacles between the remote control and the remote control sensor.

## VIZIO Remote Control Precautions

- Keep the remote dry and away from heat sources and humidity.
- If your HDTV responds erratically to the remote control or does not respond at all, check the batteries. If the batteries are low or exhausted, replace them with fresh batteries.
- When not using the remote control for a long period of time, remove the batteries.
- Do not take the batteries apart, heat them, or throw them into a fire.
- Do not subject the remote control to undue physical stress, such as striking or dropping it.
- Do not attempt to clean the remote control with a volatile solvent. Wipe it with a clean, damp cloth.
- Do not mix old and new batteries or different types of batteries.

## Inserting the remote control batteries

1. Remove the battery cover on the back of the remote control.
2. Insert two AA batteries (included) into the remote control, making sure you match the (+) and (-) symbols on the batteries with the (+) and (-) symbols inside the battery compartment.
3. Re-attach the battery compartment cover.

### Precautionary Tips for Inserting the Batteries:

- Only use the specified AA batteries.
- Do not mix new and old batteries. This may result in cracking or leakage that may pose a fire risk or lead to personal injury.
- Inserting the batteries incorrectly may also result in cracking or leakage that may pose a fire risk or lead to personal injury.
- Dispose of the batteries in accordance with local laws and regulations.
- Keep the batteries away from children and pets.

## Using a Cable or Satellite Remote

Your VIZIO remote uses codes 11758 and 10178 to work your LCD HDTV. To use a cable or satellite remote to work the LCD HDTV, refer to your cable or satellite remote user guide for more information on how to program the remote. If your cable or satellite remote uses a 5-digit code (like most Direct TV units), first try 11758 and then, if that does not work, 10178. If your cable or satellite remote uses a 4-digit code, try 1758 and then 0178 as an alternative. If your cable or satellite remote uses a 3-digit code (EchoStar or Dish Network for example), use code 627.







## Cleaning the Housing and Remote Control

1. Use a soft cloth for cleaning.
2. If the housing or remote control is seriously contaminated, use a soft cloth moistened with diluted neutral cleaner to clean the display. Wring water out of the cloth before cleaning to prevent water from penetrating into the housing. Wipe the display with a dry cloth after cleaning.



## Chapter 2 Connecting Equipment

Your HDTV has six different ways to connect your video equipment from a basic connection to the most advanced for digital signals.

Connection Quality (type)	Connector	Rear and Side Panel Color Code	Description
Best (digital)		Green	<b>HDMI (High-Definition Multimedia Interface).</b> It is the first and only industry-supported, uncompressed, all-digital audio/video interface. HDMI provides an interface between any audio/video source, such as a set-top box, DVD player, or A/V receiver and an audio and/or video monitor, such as a digital television (DTV), over a single cable.
Best (digital) ----- Good (analog)		Green	<b>DTV Coaxial RF.</b> When used for MPEG2 encoded bit streams from ATSC broadcast programming, this input takes advantage of the High Definition content. ----- <b>TV Coaxial RF.</b> This is the connection for standard NTSC TV using antenna or cable.
Best (analog)		Blue	<b>RGB PC (VGA).</b> This video input has separate red, green and blue color components. The signal carries horizontal and vertical sync information on the green signal. This is most commonly used for PC input.
Better (analog)		Yellow	<b>Component.</b> The video signal is separated into three signals, one containing the black-and-white information and the other two containing the color information. This enhancement over S-Video takes advantage of the superior picture provided by progressive scan DVD players and HDTV formats.
Good (analog)		Red	<b>S-Video.</b> The video signal is separated into two signals, one containing the black-and-white information and the other containing the color information. Separating the color in this way avoids 'cross color' effects where closely spaced black and white lines are erroneously displayed in color. It also enables text to be displayed more sharply.
Good (analog)		Red	<b>Composite.</b> The complete video signal is carried through this single pin connector. This is the most commonly used video connection.
Best (digital)		White	<b>USB (Universal Serial Bus).</b> USB is an interface port designed to connect storage devices holding data (FAT32 format: MP3 for music and JPEG for image) files without a need to power off the host (TV) unit.

**Note:** For more information, please refer to the Quick Start Guide





## Connecting Your Cable or Satellite Box

### Using HDMI

Cable and Satellite Boxes that have a HDMI digital interface should be connected to the HDMI input of the LCD HDTV for optimal results.

**Note:** To maintain the display quality, use a VIZIO certified HDMI cable. Length is available up to 10 Meters. See [www.vizio.com](http://www.vizio.com) or call 1-888-VIZIOCE (1-888-849-4623) for details.

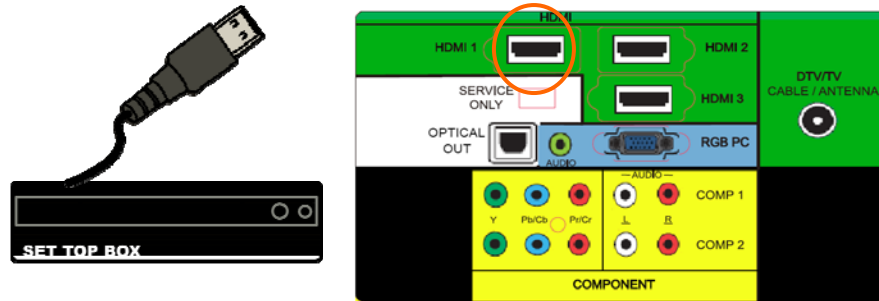

### Connecting your Cable or Satellite Box (Best)

1. Turn off the power to the LCD HDTV and HDTV Set-Top Box.
2. Connect a HDMI cable to the HDMI output of your HDTV Set-Top Box and the other end to the HDMI Input (green color area) at the rear of the LCD HDTV.
3. Turn on the power to the LCD HDTV and HDTV Set-Top Box.
4. Select HDMI using the INPUT button on the remote or side of the LCD HDTV, or directly by pressing the HDMI button on the Remote Control.

### Note:

- The HDMI input on the LCD TV supports High-bandwidth Digital Content Protection (HDCP). HDCP encrypts the transmission between the video source and the digital display for added security and protection.
- If you are already using the HDMI1 input for another component, or you do not want to use the HDMI1 input for the Set-Top Box, you can connect the Set-Top Box to the HDMI2, HDMI3 or HDMI connection.
- Refer to your HDTV Set-Top Box user manual for more information about the video output requirements of the product or consult your cable or satellite operator.



**For Cable or Satellite Boxes with DVI:**

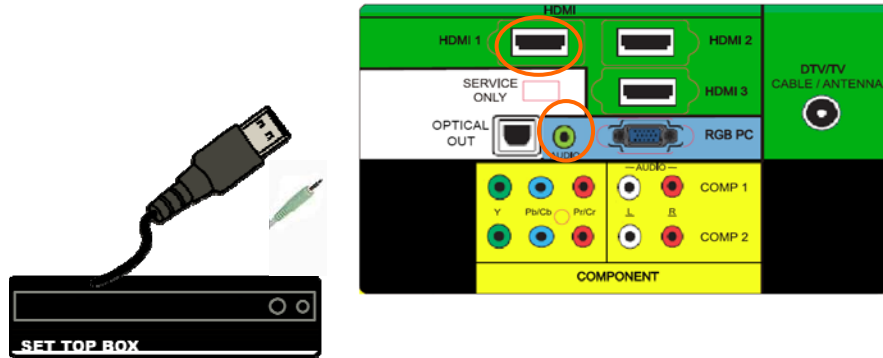

1. Turn off the power to the LCD HDTV and HDTV Set-Top Box.
2. Using a HDMI-DVI cable, connect the DVI end to your HDTV Set-Top Box and the HDMI end to the HDMI2 Input (green color area) at the rear of the LCD HDTV.
3. Using an audio cable (1/8' stereo connector on the going into the TV), connect the cable to the audio output connectors associated with the DVI output on your HDTV Set-Top Box and connect the other end to the audio associated with the RGB input (blue area) at the rear of the LCD HDTV.
4. Turn on the power to the LCD HDTV and HDTV Set-Top Box.
5. Select HDMI2 using the INPUT button on the remote or side of the LCD HDTV, or directly by pressing the HDMI button on the Remote Control.

**Note:**

- The HDMI input on the LCD TV supports High-bandwidth Digital Content Protection (HDCP). HDCP encrypts the transmission between the video source and the digital display for added security and protection.
- If you are already using the HDMI2 input for another component, or you do not want to use the HDMI2 input for the Set-Top Box, you can connect the Set-Top Box to the HDMI1, HDMI3 or HDMI connection. The LCD TV will recognize the DVI connection and obtain audio information from the audio connectors on the rear of the TV.
- Refer to your HDTV Set-Top Box user manual for more information about the video output requirements of the product or consult your cable or satellite operator.



## Using Component Video

### Connecting your Cable or Satellite Box (Better)

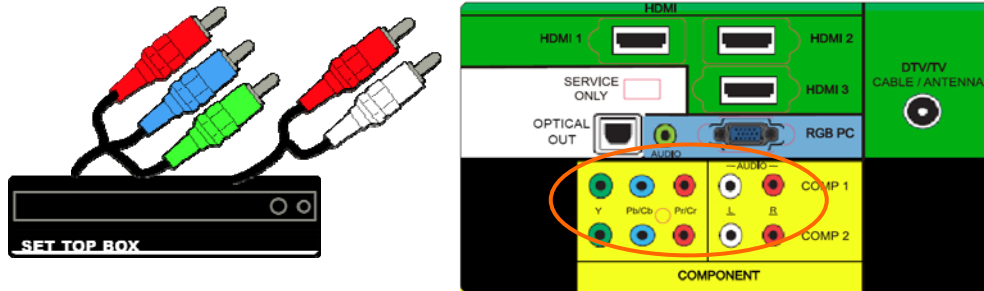

1. Turn off the power to the LCD HDTV and HDTV Set-Top Box.
2. Connect the Y (green color) connector on your HDTV Set-Top Box to the corresponding Y (green color) connector in the Comp 1 group (yellow color area) at the rear of the LCD HDTV.
3. Connect the PbCb (blue color) connector on your HDTV Set-Top Box to the corresponding Pb (blue color) connector in the Comp 1 group (yellow color area) at the rear of the LCD HDTV.
4. Connect the PrCr (red color) connector on your HDTV Set-Top Box to the corresponding Pr Cr (red color) connector in the Comp 1 group (yellow color area) at the rear of the LCD HDTV.
5. Using an audio cable (white and red connectors), connect the cable to the audio output connectors associated with the Component output on your HDTV Set-Top Box and connect the other end to the audio connectors associated with the Comp 1 input (yellow color area) at the rear of the LCD HDTV.
6. Turn on the power to the LCD HDTV and HDTV Set-Top Box.
7. Select Comp 1 using the INPUT button on the remote or side of the LCD HDTV, or directly by pressing the COMP button on the Remote Control.

#### Note:

- If you are already using the Comp 1 input for another component, or you do not want to use the Comp 1 input for the Set-Top Box, you can connect the Set-Top Box to the Comp 2 connections on the side of the TV.
- Refer to your HDTV Set-Top Box user manual for more information about the video output requirements of the product or consult your cable or satellite operator.



## Connecting Coaxial (RF)

### Using Your Antenna or Digital Cable for DTV

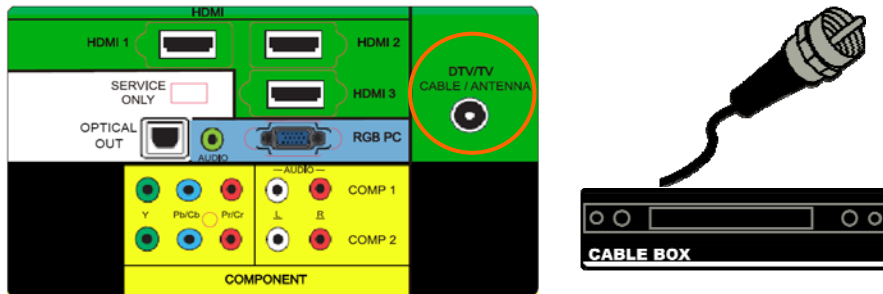

1. Turn off the power to the LCD HDTV.
2. Connect the coaxial (RF) connector from your antenna or digital cable to the DTV/TV CABLE/ANTENNA connector at the rear of the LCD HDTV.
3. Turn on the power to the LCD HDTV.
4. Select TV using the INPUT button on the remote or side of the LCD HDTV, or directly by pressing the TV button on the Remote Control.

#### Note:

- Not all digital TV broadcasts are High Definition (HD). Refer to the program guides, or consult your cable, satellite or TV station operator.
- Digital broadcasts are not available in all areas. Refer to [www.antennaweb.org](http://www.antennaweb.org) for detailed information.
- Make sure the antenna and coaxial cable are correctly grounded.



## Using Your Antenna or Cable for TV

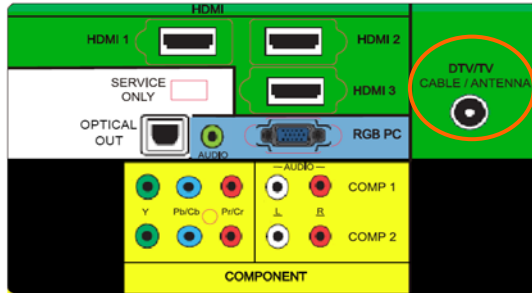

1. Turn off the power to the LCD HDTV.
2. Connect the coaxial (RF) connector from your antenna or cable to the DTV/TV CABLE/ANTENNA connector at the rear of the LCD HDTV
3. Turn on the power to the LCD HDTV.
4. Select TV using the INPUT button on the remote or side of the LCD HDTV, or directly by pressing the TV button on the Remote Control.

## Using the Antenna or Cable through your VCR

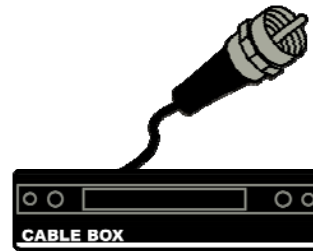
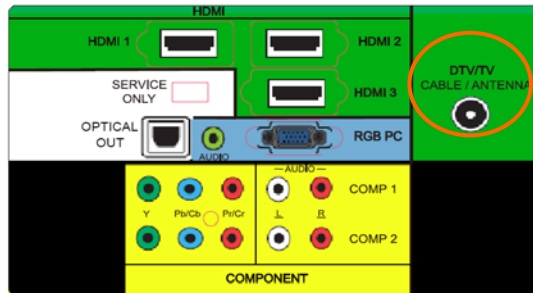

1. Turn off the power to the LCD HDTV and VCR.
2. Connect the “Output to TV”, “RF Out” or “Antenna Out” connector on the rear of your VCR to the DTV/TV CABLE/ANTENNA connector at the rear of the LCD HDTV.
3. Turn on the power to the LCD HDTV and VCR.
4. Select TV using the INPUT button on the remote or side of the LCD HDTV, or directly by pressing the TV button on the Remote Control.

**Note:** If you have an off-air antenna or cable TV, connect it to the “Antenna In” connector on the rear of your VCR.



## Connecting Your DVD Player

You have several options for connecting your DVD player to your VT420M – HDMI, Component, S-Video and Composite (AV) inputs. Based on your home theater configuration, you can decide which option is the right one for you.

### Using HDMI

DVD players that have a digital interface such as HDMI (High Definition Multimedia Interface) should be connected to the HDMI input of the VIZIO VT420M for optimal results.

**Note:** To maintain the display quality, use a VIZIO certified HDMI cable. Length is available up to 10 meters. See [www.VIZIO.com](http://www.VIZIO.com) or call 1-888-VIZIOCE (1-888-849-4623) for details.

### Connecting your DVD Player (Best):

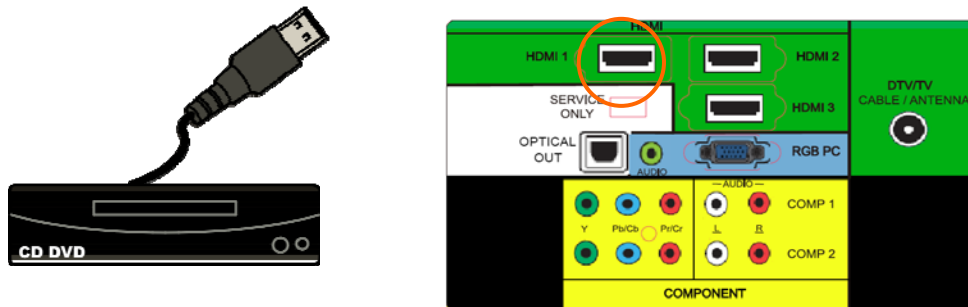

1. Turn off the power to the LCD HDTV and DVD player.
2. Connect a HDMI cable to the HDMI output of your DVD player and the other end to the HDMI Input (green color area) at the rear of the LCD HDTV.
3. Turn on the power to the LCD HDTV and your DVD player.
4. Select HDMI using the INPUT button on the remote or side of the LCD HDTV, or directly by pressing the HDMI button on the Remote Control.

### Note:

- If you are already using the HDMI1 input for another component, or you do not want to use the HDMI 1 input for the DVD player, you can connect the DVD player to the HDMI2, HDMI3 or HDMI connection.
- Refer to your DVD player user manual for more information about the video output requirements of the product.



For DVD Players with DVI:

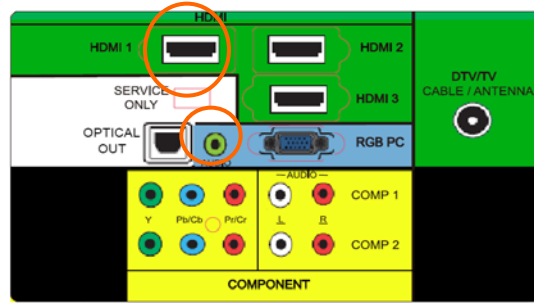

1. Turn off the power to the LCD HDTV and DVD player.
2. Using a HDMI-DVI cable, connect the DVI end to your DVD player and the HDMI end to the HDMI Input (green color area) at the side of the LCD HDTV.
3. Using an audio cable (1/8' stereo connector on the going into the TV), connect the cable to the audio output connectors associated with the DVI output on your HDTV Set-Top Box and connect the other end to the audio associated with the RGB input (blue area) at the rear of the LCD HDTV.
4. Turn on the power to the LCD HDTV and your DVD player.
5. Select HDMI-Side using the INPUT button on the remote or side of the LCD HDTV, or directly by pressing the HDMI button on the Remote Control.

Note:

- If you are already using the HDMI input for another component, or you do not want to use the HDMI input for the DVD Player, you can connect the DVD player to the HDMI1, HDMI2 or HDMI3 connection. The LCD TV will recognize the DVI connection and obtain audio information from the audio connectors on the rear of the TV.
- Refer to your DVD player user manual for more information about the video output requirements of the product.



## Using Component Video

### Connecting your DVD Player (Better):

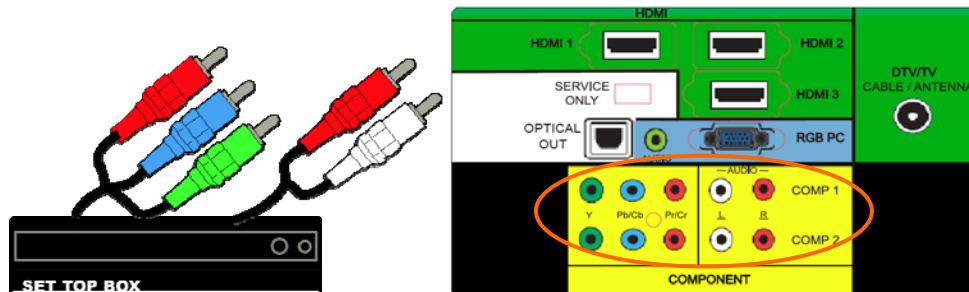

1. Turn off the power to the LCD HDTV and DVD player.
2. Connect the Y (green color) connector on your DVD player to the corresponding Y (green color) connector in the Comp 1 group (yellow color area) at the rear of the LCD HDTV.
3. Connect the PbCb (blue color) connector on your DVD player to the corresponding PbCb (blue color) connector in the Comp 1 group (yellow color area) at the rear of the LCD HDTV.
4. Connect the PrCr (red color) connector on your DVD player to the corresponding PrCr (red color) connector in the Comp 1 group (yellow color area) at the rear of the LCD HDTV.
5. Using an audio cable (white and red connectors), connect the cable to the audio output connectors associated with the Component output on your DVD player and connect the other end to the audio connectors associated with the Comp 1 input (yellow color area) at the rear of the LCD HDTV.
6. Turn on the power to the LCD HDTV and DVD player.
7. Select Comp 1 using the INPUT button on the remote or side of the LCD HDTV, or directly by pressing the COMP button on the Remote Control.

#### Note:

- If you are already using the Comp 1 input for another component, or you do not want to use the Comp 2 input for the DVD player, you can connect the DVD player to the Comp 2 connections at the rear of the TV.
- Refer to your DVD player user manual for more information about the video output requirements of the product.





## Using S-Video (AV)

### Connecting your DVD Player (Good):

1. Turn off the power to the LCD HDTV and DVD player.
2. Connect the S-Video jack on the rear of your DVD player to the S-Video jack in the AV at the side of the LCD HDTV.
3. Using an audio cable (white and red connectors), connect the cable to the audio output connectors associated with the S-Video output on your DVD player and connect the other end to the audio connectors associated with the AV input at the side of the LCD HDTV.
4. Turn on the power to the LCD HDTV and DVD player.
5. Select AV using the INPUT button on the remote or side of the LCD HDTV, or directly by pressing the AV button on the Remote Control.

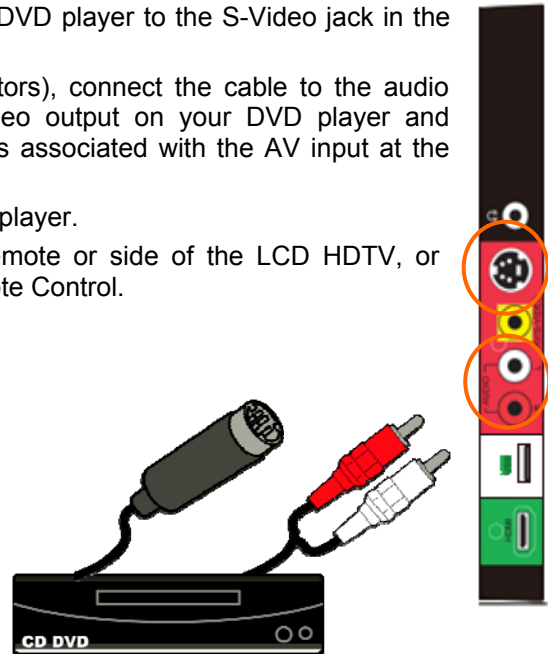

**Note:** Refer to your DVD player user manual for more information about the video output requirements of the product.



## Using Composite (AV) Video

### Connecting your DVD Player (Good):

1. Turn off the power to the LCD HDTV and DVD player.
2. Connect the Video (yellow color) connector on your DVD player to the Video (yellow color) connector in the AV input row (red color area) of connectors at the side of the LCD HDTV.
3. Connect the R (red color) and L (white color) audio connectors on your DVD player to the corresponding R (red color) and L (white color) audio input connectors in the AV input (yellow color area) row of connectors at the side of the LCD HDTV.
4. Turn on the power to the LCD HDTV and DVD Player.
5. Select AV using the INPUT button on the remote or side of the LCD HDTV, or directly by pressing the AV button on the Remote Control.

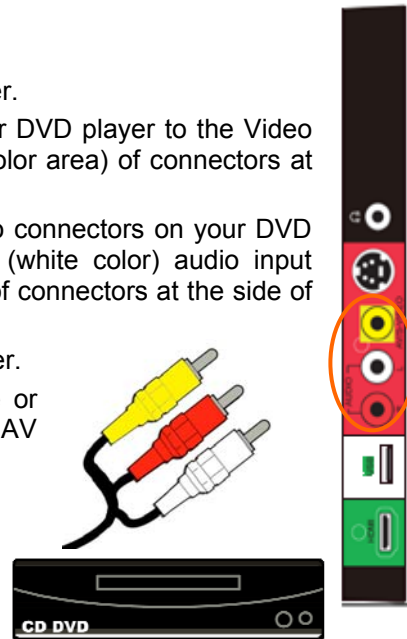

**Note:** Refer to your DVD player user manual for more information about the video output requirements of the product.



## Connecting Your VCR or Video Camera

1. Turn off the power to the LCD HDTV and VCR or Video Camera.
2. Connect the S-Video jack on the side of your VCR or Video Camera to the S-Video jack in the AV group (red area color) at the side of the LCD HDTV.
3. Using an audio cable (white and red connectors), connect the cable to the audio output connectors associated with the S-Video output on your VCR or Video Camera and connect the other end to the audio connectors associated with the AV input (red color area) at the side of the LCD HDTV.
4. Turn on the power to the LCD HDTV and VCR or Video Camera.
5. Select AV using the INPUT button on the remote or side of the LCD HDTV, or directly by pressing the AV button on the Remote Control.

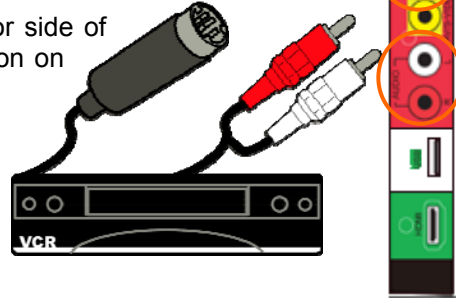

**Note:** Refer to your VCR or Video Camera user manual for more information about the video output requirements of the product.

## Connecting a USB (FAT32 Format) Storage Device

1. Connect a thumb drive, directly inserting it into the USB connection or by using an extension (if thumb drive housing is too big to have it fit in place) cable. Connecting a portable hard drive or card reader to this input is also possible
2. If your HDTV has been turned off, please turn it on.
3. The TV will start reading the contents in the USB device automatically to make sure of compatibility of files (MP3 or JPEG format).
4. Please follow the instructions in the Multimedia section to either see the pictures (picture by picture or as a slideshow) or listen to music (single song or all selected songs) or picture/music combination (slideshow with background music).



**Note:** This input is also used as factory service port. Please back up important files to prevent lost of data. Format your device to FAT32 and load your picture and music files, and enjoy your viewing. For Pause/Live TV a high speed FAT32 storage device is also needed; preferable, new and memory emptied device for a better performance at least a 1Gb of memory device must be used.



## Connecting an external Receiver/Amp

If your sound system has a SPDIF (optical) digital audio input you can connect it to the optical DIGITAL AUDIO OUT (white area) at the rear of the TV. This is active when receiving audio with the programs being viewed no matter what input is being used.

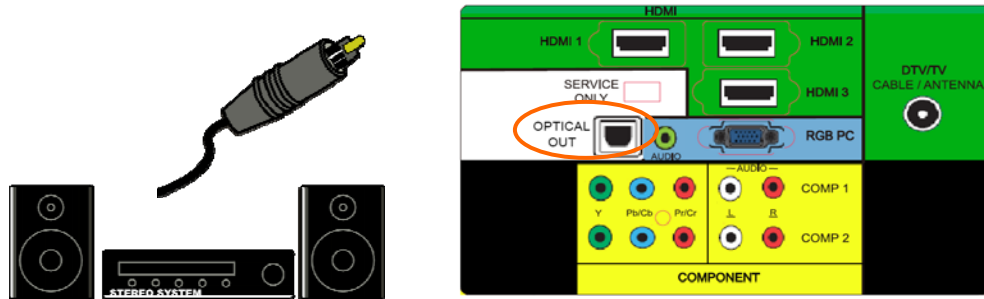

1. Turn off the power to the HDTV and Receiver/Amp.
2. Using an audio cable (optical cable), connect the cable to the audio input connectors on the Receiver/Amp and connect the other end to the OPTICAL OUT (white area) audio connectors at the rear of the LCD HDTV.
3. Turn on the power to the HDTV and Receiver/Amp.
4. Then press the **MENU/SELECT** button on the remote control to bring up the On-Screen Display (OSD) menu.
5. Press **▼** button on the remote control to select the Audio menu.
6. Press **▶** on the remote control to enter the Audio sub-menu. Press the **▼** button to highlight SPEAKERS.
7. Press **MENU/SELECT** key to select Off so that the sound from the TV will now be routed through your Receiver/Amp system.
8. Press **EXIT** key to exit the menu display.

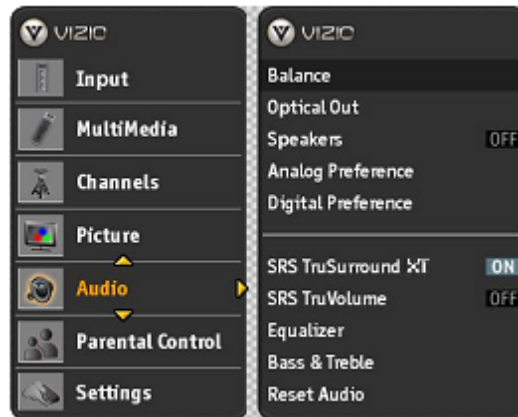

### Note:

- Refer to your Receiver/Amp user manual to select the corresponding audio input.
- The audio output is not amplified and cannot be connected directly to external speakers.



## Connecting a PC (Computer)

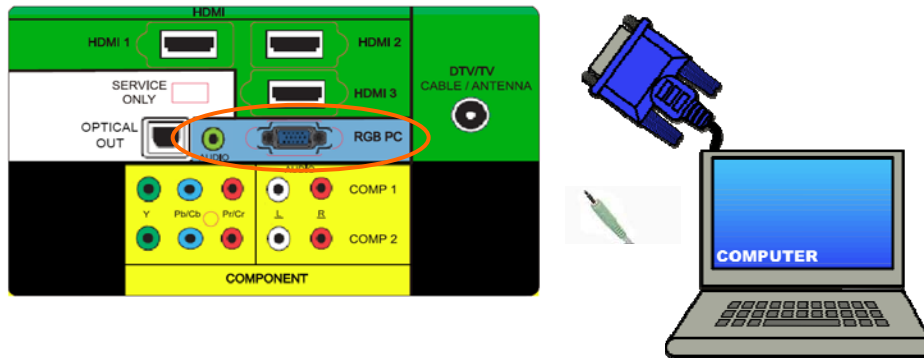

1. Turn off the power to the LCD HDTV and PC Computer.
2. Connect a 15-pin D-Sub RGB (VGA) cable to the RGB output of your pc computer and the other end to the RGB PC input (blue area) at the rear of the LCD HDTV.
3. Using a 1/8" stereo cable, connect the Audio Out on your pc computer to the RGB PC Audio input (blue area) at the rear of the LCD HDTV.
4. Turn on the power to the LCD HDTV and PC Computer.
5. Select RGB using the INPUT button on the remote or side of the LCD HDTV.

### Note:

- For a better picture quality when connecting a pc computer through RGB PC, set your pc computer timing mode to VESA 1366x768 at 60Hz. For the best picture quality, please refer to the pc or graphic card's user guide to find out if it is capable of an output of 1920x1080 at 60Hz resolution.
- Refer to your pc computer user manual for more information about the video output requirements of the product.
- A RGB (VGA) cable and stereo mini jack cable are not included and can be purchased at an electronics store.



## Preset PC Resolutions

If connecting to a PC through the RGB PC input, set the TV timing mode to VESA 1920x1080 at 60Hz for better picture quality (refer to the graphic card's user guide for questions on how to set this timing mode). Please see the table below for the factory preset resolutions, for the best resolution that can be obtained through RGB PC input when video card supports 1920x1080 resolution.





Mode No.	Resolution	Refresh (Hz)	H.Freq (kHz)	V.Freq (Hz)	H.Sync	V.Sync	Pixel Freq (MHz)
1	640x480	60	31.47	59.94	N	N	25.18
2	640x480	75	37.50	75.00	N	N	31.50
3	720x400	70	31.46	70.08	N	P	28.32
4	800x600	60	37.88	60.32	P	P	40.00
5	800x600	72	48.08	72.19	P	P	50.00
6	800X600	75	46.88	75.00	P	P	49.50
7	1024x768	60	48.36	60.00	N	N	65.00
8	1024x768	70	56.48	70.07	N	N	75.00
9	1024x768	75	60.02	75.03	P	P	78.75
10	1360x768	60	47.55	59.81	P	P	85.50
11	*1920x1080	60	66.65	60.00	P	P	136.50

**NOTES:** N = Negative, P = Positive, \* = Primary Mode.



## Chapter 3 Setting Up to Watch Television

### Basic LCD HDTV Start Up

1. **Connect Audio and Video Cables**  
Connect audio and video cables from the desired components to your HDTV as described in “Connecting Devices.”
2. **Connecting the Power Cable**  
Connect one end of the power cord to the power cord connector on the back of your HDTV. Then connect the other end into a power outlet.
3. **Turning Power On**  
Press  on the remote control to turn on your HDTV.
4. **Initial Setup**  
The Welcome Screen showing the *Language* screen option. Press  or  to highlight your language, and then press **MENU/SELECT** key to select it.
5. The *Mode Setting* screen opens. Select between **Home Mode** and **Retail Mode**, selecting Home Mode will give you an opportunity to save energy. Press the **MENU/SELECT** button. If Retail Mode is selected by mistake; the next option will allow you to switch your selection back to Home Mode.
6. Press the **MENU/SELECT** button to confirm your choice.
7. Next screen will provide you the option to select your Time Zone, press  or  to select your choice. Press **MENU/SELECT** to confirm the selection.

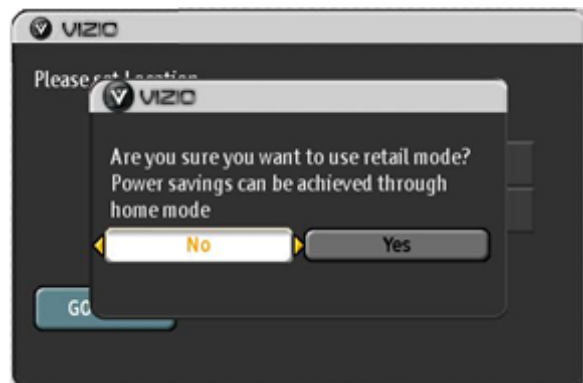
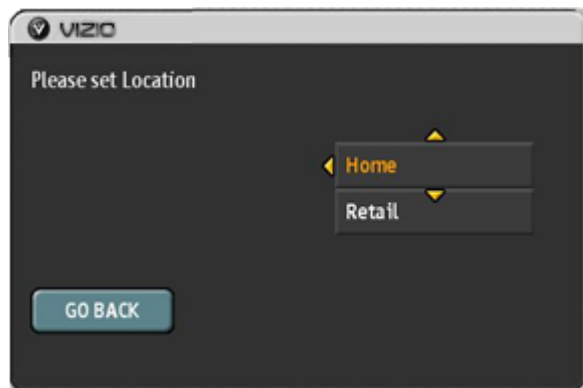

If your Time Zone observes the daylight savings, the next display will give the choice to select or no select it. Highlight your choice and press **MENU/SELECT** button to confirm your selection.

8. At this point if you have an outdoor antenna or use a cable service (No set-top box), the signal source can be selected.  
Press ▲ or ▼ to select your input source (Antenna or Cable), then press **MENU/SELECT** button to confirm it. The scanning of the channels will start.

**NOTE:** Select Cable only if you receive your cable service without a set-top box.

9. The *Channel Scan progress* screen opens if you selected *Scan*. At this point if you are using a cable or satellite set-top box, please press **MENU/SELECT** button to exit this process and use your cable box to select the channels.

**Note:** If you select Stop Scan, you can scan channels at a later time by selecting Channels menu, and then and select the Scan Channels option in the menu.

10. If you let the TV finishing the channel scan, the next screen will give the option to continue.

11. At this point, you can either let the TV do the final two steps automatically or press the **MENU/SELECT** key to continue and finish this procedure.

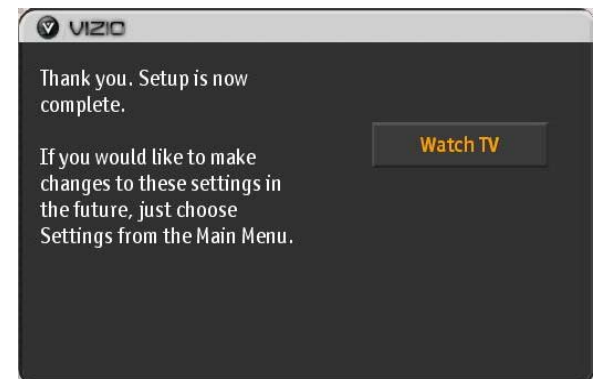
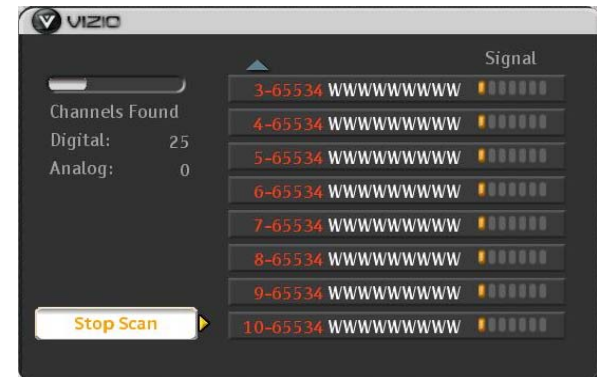
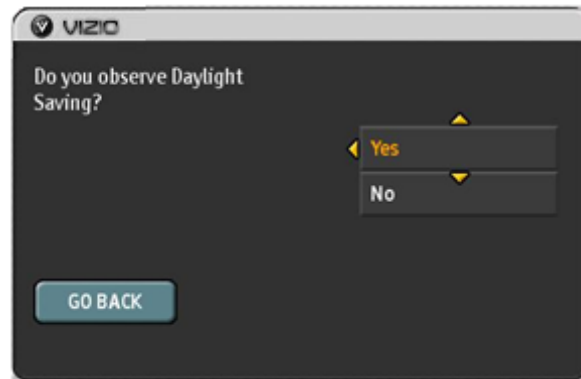

**Note:** DTV digital broadcast is not available in all areas. Refer to [www.antennaweb.org](http://www.antennaweb.org) to get information about availability in your area, antenna types, and in which direction to point your antenna. The channel availability through cable depends on which channels your cable operator supplies in Clear QAM. Consult your cable operator for more information.





## Selecting Inputs

1. Press **INPUT** on the remote or on the side of your HDTV to select the input source that matches the connection you made on the back of your HDTV. A repeated press of **INPUT** cycles you through the options.
2. Turn on your component (cable box, VCR, satellite receiver, DVD player, etc.). You should see a picture on your HDTV. If you do not see a picture, press **INPUT** repeatedly until you do see a picture.



**Note:** If the selected input is RF, your HDTV needs to be on either channel 3 or 4 to match the channel on the VCR, cable box, external TV tuner or satellite receiver. Refer to the User's Manual of your equipment for details. This type of configuration is most common with older SD (480i) receivers.

**Note:** Your HDTV will display the television station or program selected by the cable box, VCR, external tuner, or satellite receiver. Use the remote control that came with that component to change programs or channels. If the service being used is the one which setup includes a box with two outputs for two different (distant) rooms, then scanning channels will help you to find the signal. Be aware that the channel to be selected varies from provider to provider. You may have to call your provider to get the specific channel when using your HDTV. Some examples of these channels are 105, 106, 115, and 116.

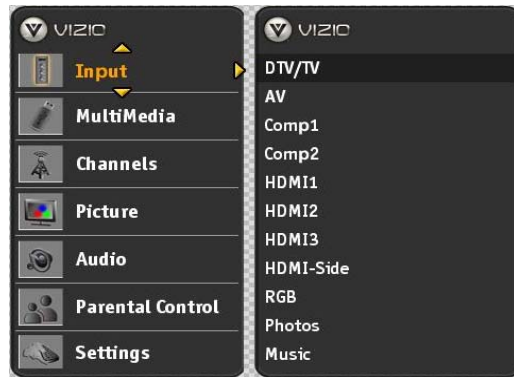

## Setting the Picture to User's Preferences

1. Press **MENU/SELECT** on the remote control. The *Main* menu opens.
2. Press **▲** or **▼** to select *Picture option*, then press **▶**. The *Picture Settings* menu opens.
3. Press **▶** to see the different Picture modes.
4. Press **▲** or **▼** to select *Custom mode*.
5. Press **MENU/SELECT** key to select it.



7.

6. The Custom menu opens. Parameters as Brightness, Contrast, Saturation, Hue, Sharpness and Backlight are adjustable; Contrast Enhancement, Color Stretch and DCR are switchable On or Off, and Color Temperature has selections of Cool, PC, Normal and Custom. Make the desired changes and exit the menu by pressing **EXIT** on the remote control.



## Using the INFO Guide

1. Press **INFO** on the remote to display program information for the channel you are watching.
2. Press **INFO** to exit or wait for it to disappear automatically.

The following information is displayed when the **INFO** key is pressed:

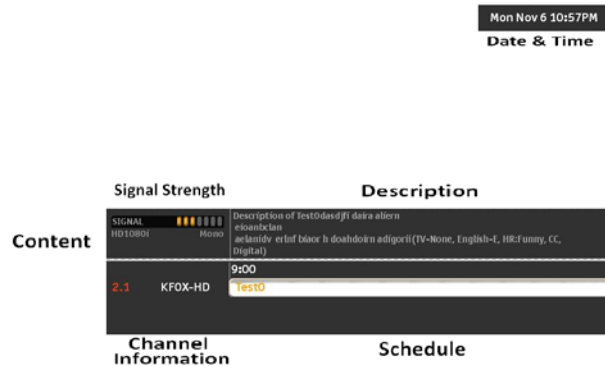

**Date & Time** – It shows the current date and time of the day of your local area, as long as the correct time zone had been selected.

**Signal Strength** – It displays how strong the signal is being received, it shows as colored bars with green color indicating a strong signal.

**Description** – It displays the name of the program being viewed as well as the Parental Control rating, if Closed Captioned and if it is a digital channel.

**Content** – It shows the type (480i, 1080i, etc.) signal and what language the program is being viewed.

**Channel Information** – It displays the header of channel physical address as well as the name of broadcaster.

**Schedule** – It displays up two hours of programming.

## Displaying the Information Guide Banner

When you change channels or inputs a information banner displays the status of your HDTV, showing either the channel number or the name of the input being switch to.



## Watching a TV Program

Before you start watching TV, please verify that all cables or antenna connections are secure, and the power cord is plugged into a correctly grounded electrical outlet or surge protector.

1. Press the power button on the remote or on the side of the HDTV. The VIZIO logo on the front will change from orange to white.
2. There are 3 options for selecting your programming:
  - a. If you are using an antenna or cable connected through the DTV/TV CABLE/ANTENNA input, you can select TV directly by pressing the TV button on the remote, or by pressing the **INPUT** button on the remote or on the side of the HDTV.
  - b. If you are watching broadcasts through a cable or satellite set-top box connected by an HDMI cable, select HDMI directly by pressing the HDMI button on the remote, or by pressing the INPUT button on the remote or on the side of the HDTV.
  - c. If you are watching broadcasts through a cable or satellite set-top box connected by a Component (YPbPr) cable, select Component directly by pressing the Component button on the remote, or by pressing the **INPUT** button on the remote or on the side of the HDTV.

**Note:** You should be able to see a picture. If you do not, make sure that all of the HDTV connections are secure and you have selected the correct video input source.

3. When using option 2a, press the Channel buttons on the remote or the CH+ / CH- buttons on the side of the HDTV to change the channel. *Note: The Channel buttons, on the side of the HDTV and on the remote, control will not work if you are watching a program using HDMI, Component and AV inputs.*

## Using the On-Screen Display (OSD)

1. Press **MENU/SELECT** on the remote control or the side of your HDTV. The menu opens.
2. Press **▲** or **▼** on the remote control or **VOL +** or **VOL -** on the side of your HDTV to highlight a sub-menu option.
3. Press **◀** or **▶** on the remote control or **CH +** or **CH -** on the side of your HDTV to select the highlighted sub-menu option.
4. Press **▶** on the remote control or the **MENU** on the side of your HDTV to adjust the item.
5. Press **EXIT** when finished making adjustments.
6. Press **◀** to return to the previous screen or repeatedly to exit the OSD.

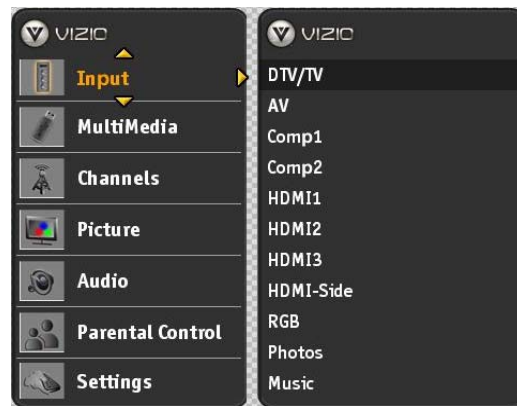

## Using the Navigation Wheel

The Navigation Wheel on the remote control is designed to make the use of the OSD easier for you, as shown below:



The **MENU/SELECT** key functions as an On switch, it activates the OSD screen when pressed once. If the OSD is already displayed, the function of this key is to select the highlighted option.

The **▲** and **▼** arrows make the access to the displayed options faster, if the arrow down is pressed and the desired option is overshoot, then pressing the arrow up will take you to the previous option or vice versa.

The **◀** and **▶** arrows make it easier for the user to navigate from the main menu to submenus. When a desired feature or option is reached, pressing the **▶** will activate or select it, while pressing **◀** will take the user to the previous menu or out of the OSD menu if currently at the main menu.

The remote control or the control buttons on the side of your HDTV control the function settings. The On-Screen Display (OSD) lets you adjust the contrast, brightness, and other settings. Changes are saved even when you turn off the TV; Your HDTV has the unique feature of saving your preferred settings to the input being used given a total of nine different selections. The OSD consists of these menu options:

**Input:** When highlighted it allows you to see all the different inputs built into the TV. There are eleven options under this selection: DTV/TV, AV, Comp1, Comp2, HDMI1, HDMI2, HDMI3, HDMI-Side, VGA, Photos and Music.

**Multimedia:** Selecting multimedia gives you the option of Photos and Music, allowing them to be combined as a presentation or slideshow with background music.

**Channels:** If the input signal is either antenna or cable (no set-top box) service, using the channel option allows scanning the signal for channels. Under this option, you will find the following choices and features: Master List, Additional Scan, Scan Channels and Channel Name Edit.

**Picture:** This option will display all parameters which setting values would produce the video quality to the end user's preference. The choices under this selection are: Picture Settings, View Mode, Noise Reduction, Fast Response and Reset Picture.

**Audio:** This function encompasses all parameters to setup the audio preferences. The choices under this selection are: Balance, Optical Out, Speakers, Analog Preference, Digital Preference, SRS TruSurround HD, SRS TruVolume, Equalizer, Bass & Treble and Reset Audio.

**Parental Control:** This option covers all requirements to help adults on preventing children from watching undesirable content or programs. To obtain the submenu, a four-digit PIN or password needs to be input. These are the choices and features provided for this selection: Ratings Locks, Channel Locks, Front Panel Lock, Change PIN and Reset Locks.

**Settings:** Through Settings all the different global parameters which apply to the TV can be adjusted to end user preferences; Following are the choices and features of this selection: Closed Captions, Picture In Picture (PIP), Input Labels, Menu Language, Date & Time, Sleep, Smooth Motion, Smooth Motion Demo and Reset All.



## Unique TV Features

This HDTV comes with some extra features to make your TV experience more enjoyable. They are described as follows:

1. **Multimedia:** This feature allows using storage devices such as a portable hard drive or thumb drive or card reader as long as it is a **FAT32** formatted device to display the pictures (JPEG files) and play music (MP3 files) or a combination of both (pictures and music) as a slide show. Through the Photos menu, you are able to Browse (select which pictures to show and how to show them using Picture Settings from main menu), View Slideshow (select to start your slide show) and Slide Settings (select how to display the pictures; Repeat, Shuffle, Full Screen, Pace and Mode). When Entertainment Mode is selected the slide show will play background music, if MP3 files are present in your device or in a folder within the device. In the Browse display windows, you will find thumbnails of the pictures in the device or folder. If the message "No Thumbnail Preview" is shown, it means that the thumbnail is not available for this picture, but still the picture is available to be shown. Depending on the size of the picture and music files, it could take a longer time to display or change the picture as well as starting a new song.  
Through the Music menu, you are able to Browse (select what songs to play) and Music Settings (select Mode, Speed, Shuffle, Repeat, Full Screen). When Music Mode is selected, the screen will become darker to help on saving energy. If a slide show is chosen to play, uncheck Music Mode to prevent screen from darkening.

**Note:** To prevent the loss of data or important files, it is recommended to use a clean or newly formatted device or to make sure that the files have been backed up. VIZIO can not be held liable if proper measurements and recommendations are not followed to prevent the loss of important data.

Pressing either individual (TV, AV, COMP, HDMI) input keys or the **LAST** key to exit this feature.

2. **Channels:** The Channels menu has the following added features: Master List (allows you to select what channels to skip by group or individually), Additional Scan (rescan channels without the loss of previous scanned table) and Channel Name Edit (select it to name your favorite channels as well as these channels which are broadcast without any header information to preferred names or labels).
3. **Picture:** In the Picture menu the Fast Response feature is added for game players to improve picture response.
4. **Parental Control:** In this menu, the User Control Lock is added to prevent the use of the TV by individuals to whom supervision is required, after keying your password, this option will be displayed in the Parental Control menu. If it is selected, the control buttons on the side of the TV will become inactive (nonfunctional) until this option is unchecked by using the remote control to turn on the TV and going back to the Parental Control menu.
5. **Settings:** In the Settings menu two new features are added: Input Labels (allows you to name the different inputs according to your preferences) and Skip Input (selecting this option will allow you to bypass non-used inputs when pressing the Input key on the remote control), this option is applicable to all inputs, except DTV/TV.



6. **Pause-Live-TV (PLT):** This feature allows the viewer to pause the program (either from cable service without set-top box, or antenna) being watched and then to resume watching it at the point the TV was paused. The last three buttons at the bottom of the remote control operate this feature: **II** pauses the live program and starts recording for up to 29 minutes, **▶** starts the playback, **◀** and **▶** on the Navigation Wheel allows rewind and forwarding in increments of 15 seconds at a time and **■** will exit the feature to live TV. You can also press TV or AV or COMP or HDMI to exit this feature directly to the different inputs. A high speed USB 2.0 device with a minimum of 1Gb of memory plugged into the USB, port multimedia must be used for better performance of this feature.

**Note:** This feature (Pause Live TV) requires certain conditions about the USB device:

- a) At least 1 GB of memory.
  - b) Empty (no other files) formatted as FAT32 device.
  - c) Write speed higher than 10Mb/sec.
7. **Consumer Electronics Control (CEC):** This feature is only available through HDMI and allows control of other CEC compatible equipment (DVD players, Satellite receivers, etc.) through the HDMI connections. The TV receives information from the connected unit and the TV will rename the input (HDMI1, HDMI2, HDMI3 or HDMI-Side) to the specific name or brand sent by the connected unit. If the second unit is to be permanently connected; Whenever this unit is turned on, the TV will recognize it and automatically turned on (if already off). If it is decided to turn off the TV, the TV will send a signal to the connected unit instructing it to shut down helping you to save energy by turning both units off.

**Reminder:** When using the Multimedia (Photos and Music) and the Pause-Live TV (P/L TV) features a USB FAT32 formatted high speed storage device is needed with at least a storage capacity of 1Gb of memory for better performance of these features. For Pause/Live TV a high speed FAT32 storage device is also needed; preferable, new and memory emptied device for a better performance at least a 1Gb of memory device must be used.



## Adjusting Settings

When viewing DTV / TV or an HDMI, Component, or AV, or Storage Device source, the following picture adjustment OSD screens are available when you press **MENU/SELECT** on the remote control. The feature and parameter you are selecting to adjust is displayed in orange text in left-hand side of the OSD.

Press **▲ / ▼ / ◀ / ▶** to highlight and select the choice, then press **MENU/SELECT** key to select the desired adjustment, and then press the **EXIT** key when finished making adjustments. Press **◀** to return to the previous screen or repeatedly to exit the OSD.

## Adjusting Multimedia Settings

In the Multimedia feature, you have the choices of Photos and Music

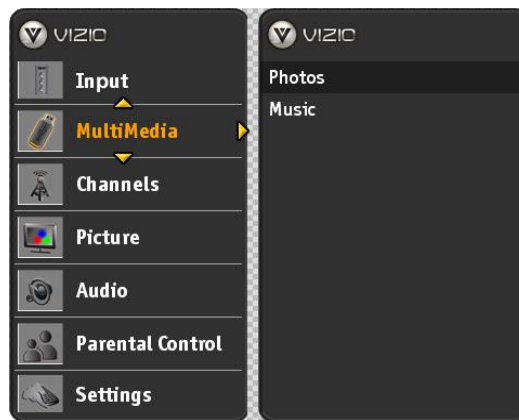

The following options are available in the Photos menu:

1. **Browse Photos** – This option switches to Photos mode in a browse view screen, allowing the user to see thumbnails of the photos, if available.
2. **View Slideshow** – This option switches to Photos mode and starts the slide show displaying the images in your USB storage device.
3. **Slide Settings** – This option allows controlling the behavior or ways of how you would like to display the images or pictures. Under these settings, the choices are: Repeat, Shuffle, and Entertainment Mode (background music is played), Full Screen (it stretches the picture to fill the screen) and Speed (elapsed time between pictures).

The following options are available in the Music menu:

1. **Browse Music** – This option switches to Music mode in a browse view screen allowing the user to see the screen displaying the description and titles of the songs available in the USB storage device.
2. **Music Settings** – This option allows to set up the options on how you would like to listen to the songs. Under these settings, the choices are: Repeat, Song Gap (elapsed time between songs), Shuffle, Music Mode (energy savings mode; if selected on Entertainment Mode, the displayed pictures will be darker), Entertainment Mode (music and slide show) and Full Screen.



### Adjusting Channels settings

If you did not set up your HDTV for DTV / TV channels using the Initial Setup screens or if your setup has changed, you can do so from the TV menu.

Press ▲ / ▼ / ◀ / ▶ to highlight and select the choice, then press **MENU/SELECT** key to select the desired adjustment, and then press the **EXIT** key when finished making adjustments. Press ◀ to return to the previous screen or repeatedly to exit the OSD.

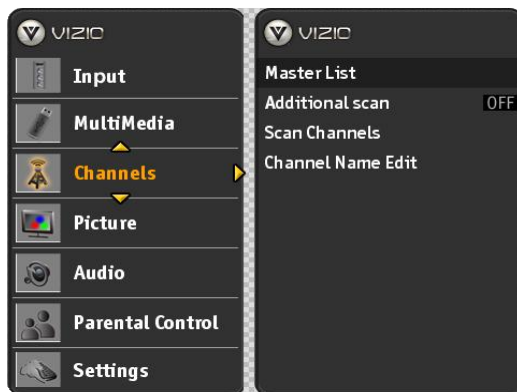

The following options are available in the TV menu:

1. **Master List** - After your HDTV has stored all of the available channels in memory, you can skip channels from the channel list that you do not want to see and which signals are not strong enough to produce a good picture. You can still tune to skipped channels using the numbered keys on the remote control.
2. **Additional Scan** - Turning this option On allows your HDTV to scan for additional channels if Scan Channels had been interrupted.
3. **Scan Channels** - This option allows scanning for available channels in your local area; either over the air (antenna) or cable service (no set-top box) is being used. After all of the available channels have been scanned, they are placed in the master list.
4. **Channel Name Edit** - This option allows you either to edit the given name or to assign a new name to the scanned channels, to your preference.
5. **Time Zone** - Setting the correct Time Zone for your area ensures that the correct program times are shown in the Electronic Program Guide.
6. **Daylight Saving** - Setting the daylight saving time for your area will ensure that the correct program times are shown in the Electronic Program Guide.





## Adjusting the Picture

When viewing DTV / TV or an HDMI, Component, or AV source, the following picture adjustment OSD screens are available when you press **MENU/SELECT** on the remote control. The source you are viewing is displayed in orange text in the bottom left-hand corner of the OSD.

Press **▲ / ▼ / ◀ / ▶** to highlight and select the choice, then press **MENU/SELECT** key to select the desired adjustment, and then press the **EXIT** key when finished making adjustments. Press **◀** to return to the previous screen or repeatedly to exit the OSD.

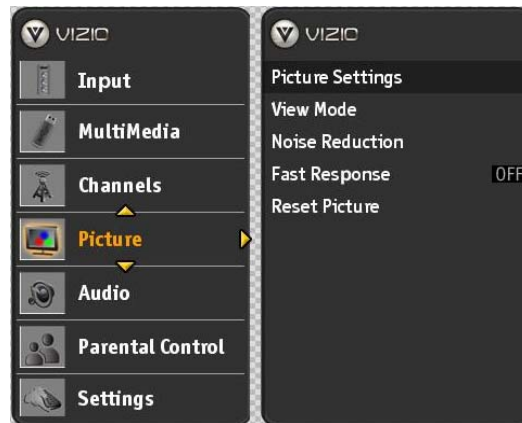

The following options are available in the *Picture* menu:

1. **Picture Settings** - Select *Custom, Standard, Movie, Game (Sports)*.
2. **View Mode** - This option lets you determine how the image appears on the screen. Select *Normal, Expanded, Full Screen, or Panoramic*.
3. **Noise Reduction** – This option diminishes picture artifacts caused by the digitizing of moving images, the settings being Off, Low, Medium and High.
4. **Fast Response** – This option increases the screen display response when games are being played on the source.
5. **Reset Picture** – This option allows the user to reset any changed value in the Picture menu to the factory value without altering other menu settings.



## Adjusting the Picture Settings

Press ▲ / ▼ / ◀ / ▶ to highlight and select the choice, then press **MENU/SELECT** key to select the desired adjustment, and then press the **EXIT** key when finished making adjustments. Press ◀ to return to the previous screen or repeatedly to exit the OSD.

The options of Home, Movie, Vivid and Game are preset settings; if you desire to change the look of the image being viewed selecting Custom will open the menu to make the changes.

The following options are available in the Picture Settings menu under Custom option:

- Brightness** – This option adjusts the black levels in the picture. If the brightness is too low you will not be able to see the detail in darker parts of the picture and if the brightness is too high the picture will look washed out.
- Contrast** – This option adjusts the white levels in the picture. If the contrast is too low the picture will look washed out and if the contrast is too high you will not be able to see any detail in the bright parts of a picture.
- Saturation** – This option setting adjusts the amount of color in the picture.
- Hue** – This option adjusts the hue of the picture. The easiest way to set hue is to look at flesh tones and adjust for a realistic appearance. In most cases, the default middle position is correct.
- Sharpness** – This option setting adjusts the sharpness of the edges of elements in the picture. It does not produce detail that otherwise does not exist. This adjustment is helpful when viewing SD (Standard Definition) sources, as it provides only contour peaking, and should be at a low setting with HD sources.
- Backlight** – Backlight adjusts the overall brilliance of the picture. It does not affect the Brightness (black level) or Contrast (white level) of the picture. If DCR is activated, backlight adjustment is not available.
- Contrast Enhancement** – This option enhances the white levels in the picture.
- Color Stretch** – This option will help the overall color saturation of the image being displayed on the screen.
- Color Temperature** – Color Temperature is the “warmness” or “coolness” of the white areas of the picture. Adjust your HDTV color temperature preferences: Cool, PC, Normal and Custom are the choices. Custom allows adjusting the *Red*, *Green*, and *Blue* color levels.
- DCR (Dynamic Contrast Ratio)** - DCR (Dynamic Contrast Ratio) automatically adjusts the contrast between brighter and darker scenes. When activated, adjustment of the Backlight is not available.

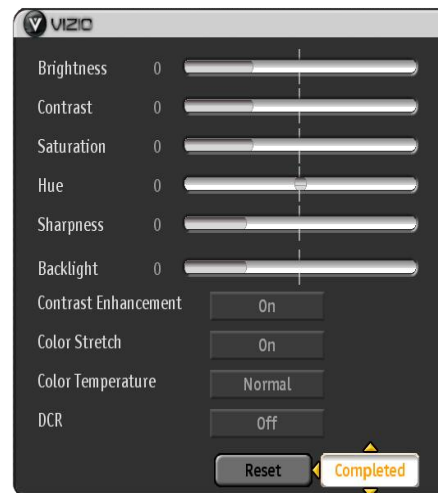
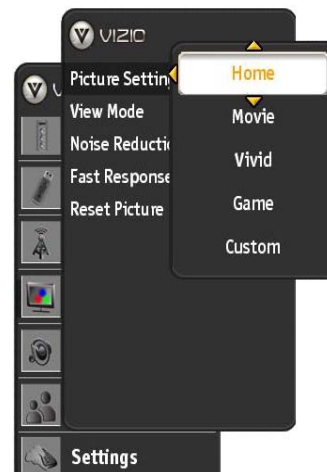
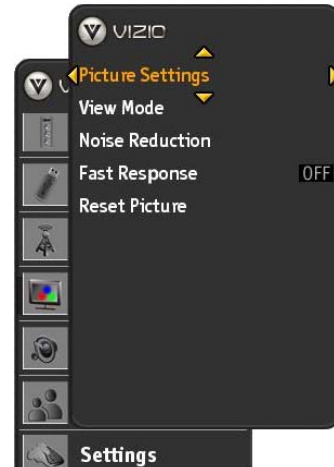

## Adjusting the Audio Settings

When viewing a DTV / TV or an HDMI, Component, AV, or PC source, the following audio adjustment OSD screens are available when you press **MENU/SELECT** on the remote control. The source you are viewing is displayed in orange text in the bottom left-hand corner of the OSD.

Press **▲ / ▼ / ◀ / ▶** to highlight and select the choice, then press **MENU/SELECT** key to select the desired adjustment, and then press the **EXIT** key when finished making adjustments. Press **◀** to return to the previous screen or repeatedly to exit the OSD.

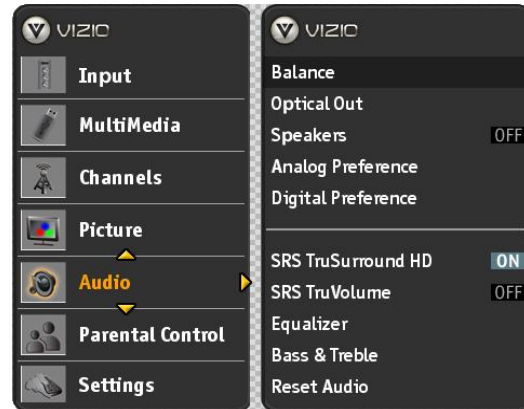

The following options are available in the *Audio* menu:

1. **Balance** – This option allows for compensation of one channel (Left or Right Audio) being higher or lower than the other in order to bring stereo effect back into balance.
2. **Optical Out** – This option allows selection of the type of processing for the SPDIF (Optical connector) when used with a Receiver/Amplifier/Home Theatre system.
  - **Auto** – Select to detect either Dolby Digital or PCM audio automatically to play through stereo amplifier if Optical Out is being used.
  - **Forced PCM** - Select to output PCM audio to your stereo amplifier if Optical Out is being used.
3. **Speakers** – Turn off the internal TV speakers when listening to the audio through your home theater system.
4. **Analog Preference** – This option allows turning the analog audio preference Mono or Stereo or selecting the SAP (alternate language) of the broadcast signal.
5. **Digital Preference** – This option allows selecting the language (English, French or Spanish) preference of the digital audio.
6. **SRS TruSurround HD** — Turn the simulated surround feature *On* or *Off*.
7. **SRS TruVolume™** — When the programming switches to a commercial or when changing from channel to channel, volume fluctuations occur. The SRS TruVolume™ provides the listener with a comfortable and consistent volume level.
8. **Equalizer** – To adjust the level for different frequencies of the Stereo audio signal, use this option.
9. **Bass & Treble**– Adjust low and high frequency sounds. You can also adjust for bass and treble boost or attenuation.
10. **Reset Audio** – This option allows the reset of any changes done to these parameters within the Audio menu.



## Adjusting the Parental Control settings

When viewing a DTV / TV or a component, or AV source, the following parental control OSD screens are available within the *Parental Control* OSD menu. Parental Control options are not available when viewing an HDMI source.

You can restrict certain channel and program viewing by turning on parental controls. Selected programs, movies and channels can then be made available only after an authorized password has been entered. **The default password is 5351.**

Press **▲ / ▼ / ◀ / ▶** to highlight and select the choice, then press **MENU/SELECT** key to select the desired adjustment, and then press the **EXIT** key when finished making adjustments. Press **◀** to return to the previous screen or repeatedly to exit the OSD.

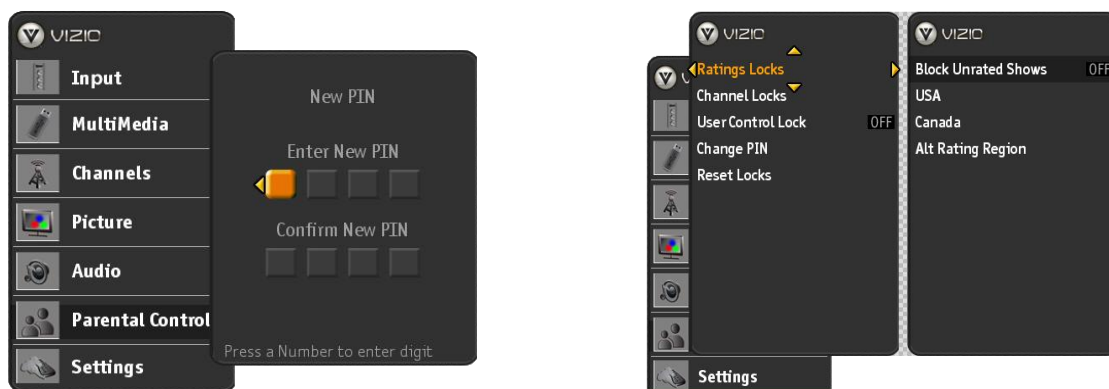

The following options are available in the *Parental* menu:

1. **Ratings Locks** – This option allows blocking channels based on the ratings established by regulations.
2. **Channel Locks** – This option allows blocking channels no matter what content.
3. **User Control Lock** – This option allows blocking the usage of the controls panel on side of your HDTV.
4. **Change PIN** – This option allows creating a new PIN (password) to use the Parental Control features.
5. **Reset Locks** – This option allows resetting the changes made in the parental control feature menu, using this option there is no need to individually reset the settings unless it is desired.



The following options are available Ratings Locks menu:

1. **Block Unrated Shows** – This option allows blocking of unrated content.
2. **USA - TV** – This option allows blocking of selected TV or Cable channels based on ratings established for US broadcasts. Select the desired rating and press **MENU/SELECT** to block (lock) or unblock (unlock).



TV Rating Definitions:	TV Rating Content Definitions
Y – All children	A – All subratings
Y7 – Older children	D – Sexual dialog
G – General audience	L – Adult language
PG – Guidance suggested	S – Sexual situations
14 – Strongly cautioned	V - Violence
MA – Mature audience	FV – Fantasy violence



3. **USA - Movie** – This option allows blocking of movies based on ratings established by the MPAA. Select the desired rating and press **MENU/SELECT** to block (locked) or unblock (unlocked).

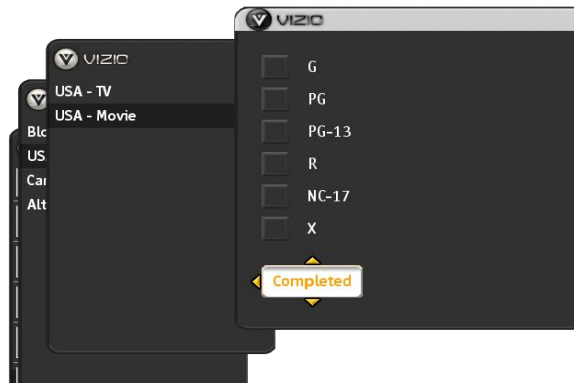

**Movie Rating Definitions:**

G – General audience  
 PG – Parental guidance suggested  
 PG-13 – Recommended for children 13 years of age or older  
 R – Mature audience  
 NC-17 – No one under 17 years of age  
 X – No one under 17 years of age

4. **CAN – French** – This option allows blocking of selected French Canadian English TV or Cable channels based on age.



**Movie Rating Definitions:**

G – General audience  
 8 ans+ – General – not recommended for young children  
 13 ans+ – Not suitable for children under 13 years of age  
 16 ans+ – Not suitable for under 16 years of age  
 18 ans+ – Adults only



5. **CAN – English** – This option allows blocking of selected Canadian English TV or Cable channels based on age

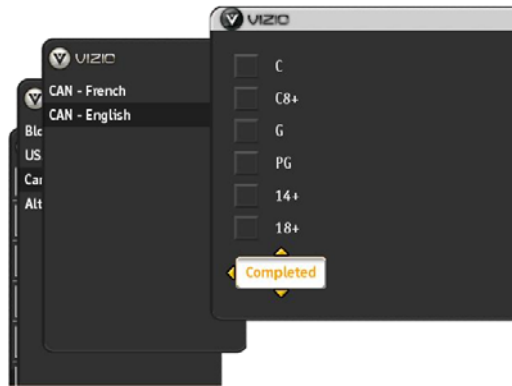

Movie Rating Definitions:	
C	– Children
C8+	– Children 8 years or older
G	– General programming, suitable for all audiences
PG	– Parental guidance
14+	– Viewers 14 years or older
18+	– Adults programming

6. **Access Code Edit** - The *Access Code Edit* option lets you change the password used to access the *Parental* menu. The default password from the factory is **5351**. Enter the new 4-digit password using the number buttons on the remote. Enter the password a second time to confirm you entered it correctly.



**NOTE:** Make sure you write down and store the new password in a secure place.



## Adjusting the Settings

When viewing a DTV / TV or an HDMI, Component, AV, or PC source, the following setup adjustment OSD screens are available when you press **MENU/SELECT** on the remote control.

**NOTE:** When a computer is the source, the CC option is not available.

Press **▲ / ▼ / ◀ / ▶** to highlight and select the choice, then press **MENU/SELECT** key to select the desired adjustment, and then press the **EXIT** key when finished making adjustments. Press **◀** to return to the previous screen or repeatedly to exit the OSD.

The following options are available in the *Settings* menu:

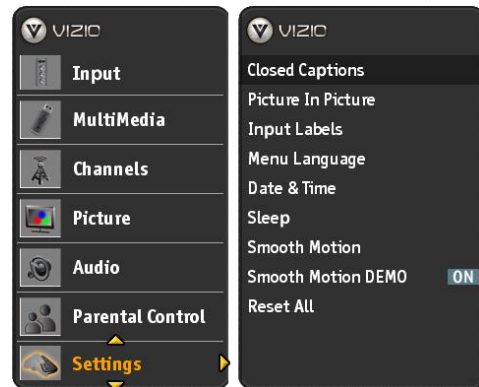

1. **Closed Captions** – Adjusts Closed Caption settings of the program being viewed.
2. **Picture In Picture** – Allows watching two different signal sources simultaneously.
3. **Input Labels** – Allows assigning names to the different input connections to your preference.
4. **PC Settings** – Allows to adjust the Horizontal, Vertical, Clock, Phase and select Power Saving while using a computer as signal source.
5. **Menu Language** – Select the language displayed in the OSD menus, the choices are: English, French and Spanish.
6. **Date & Time** – Allows adjusting the displayed time and date.
7. **Sleep** – Your HDTV can be set to turn off automatically after 30, 60, 90, or 120 minutes.
8. **Smooth Motion™** – This feature suppresses motion judder. Judder is often observed as a ‘stuttering’ of the image when the camera pans across a scene, or there is horizontal motion in the scene. Film is typically shot at 24 frames per second. Any time that film is displayed at a frame rate that is not an even multiple of 24, judder will result. For presentation on a TV, film goes through a process and comes out at frame-rate of 30 or 60, which are those used in TV.
9. **Smooth Motion Demo** – This option splits the screen in half, displaying the picture without Smooth Motion processing on the right half of the screen, and with Smooth Motion processing on the left half of the screen. This allows you to determine the best results for your settings. Press the MENU/SELECT key to exit demo.
10. **Reset All** – Allows resetting the TV features to factory values on all adjustable parameters. If you had selected to have your TV under Parental Control, these choices require the PIN to prevent unauthorized changes, and they are described as follows:

- **Start set up Wizard** – Use this function to return to the Initial Setup when the TV was used for the first time.

**Note:** Previously scanned channels will be removed.

- **Reset All Settings** – Settings are reset to factory defaults.

**Note:** This does NOT reset the Parental Control Password, and the previously scanned channels are not removed.





## PIP (Picture-in-Picture)

This option sets the parameters for a second (sub) screen, allowing two sources to be viewed simultaneously.

Press the **PIP** key to activate this feature, a sub-screen will come up on the bottom right hand side corner of the TV display.

Press **SWAP** key to switch between main and PIP screen.

The following options are available and applicable to the **PIP** option menu:

1. **Source** – When select this option allows selecting the signal source from out of the applicable choices, these choices will be displayed on the OSD.
2. **Swap** – This option allows exchanging or swapping the screens, main to sub-screen and vice versa.
3. **Position** – This option allows placing the sub-screen at the location of your choice: top left, top right, bottom left or bottom right hand corners.
4. **Size** – By using this option, you will be able to select the size of the sub-screen to your choice. The sizes are: Small (factory setting), Medium and Large.
5. **Audio** – This option allows switching the audio to the sub-screen signal source.

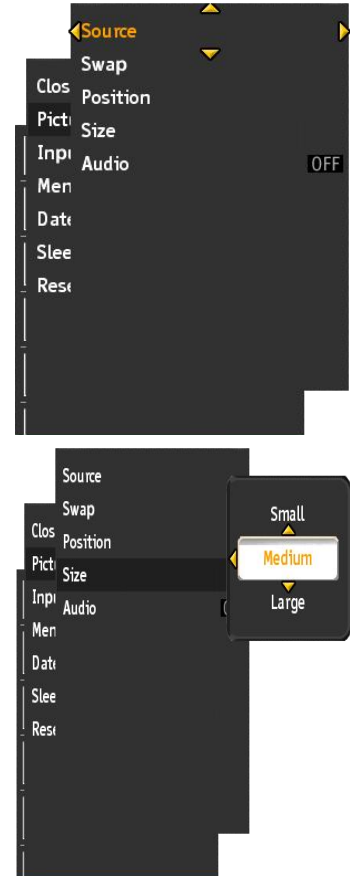

See below for detailed information regarding the PIP sources.

		SUB						
MAIN \ SUB		DTV/TV	AV(CVBS)	AV(S-Video)	Component 1	Component 2	HDMI	RGB
DTV/TV					✓	✓	✓	✓
AV(CVBS)					✓	✓	✓	✓
AV(S-Video)							✓	
Component 1		✓	✓				✓	
Component 2		✓	✓				✓	
HDMI		✓	✓	✓	✓	✓		✓
RGB		✓	✓				✓	

“✓” – Indicates which inputs are available for PIP and POP modes.

**Note: HDMI does not support 1080p in PIP feature. RGB supports up to 1024x768@60Hz in the PIP feature.**



## Understanding Viewing Modes

Your HDTV features the following viewing modes.

### Expanded Mode

The original 4:3 aspect ratio (1.33:1 source) is preserved, so black bars are added to the left and right of the display image. Standard TV broadcasts are displayed with a 4:3 Aspect Ratio. Movies in 4:3 Aspect Ratio may be referred to as pan-and-scan or full frame. These movies were originally filmed in 16:9 (widescreen), and then modified to fit a traditional TV screen (4:3).

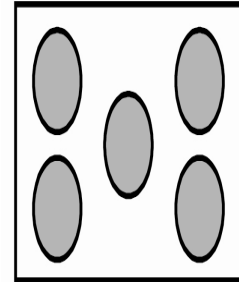

### Normal Mode

This is the native mode (1 :1), the display area size depends on the input format ( like 480i, 1080i, etc)

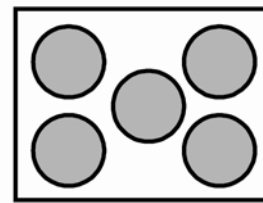

### Full Screen Mode

When watching a widescreen program (1.78:1 source) with black bars on the sides, the display image will stretch to fill the TV screen. People will appear wider than they really are. If you are watching a widescreen (1.85:1 or 2.35:1 source) program or movie, there will still be black bars at the top and bottom. This mode is available only when watching a widescreen program.

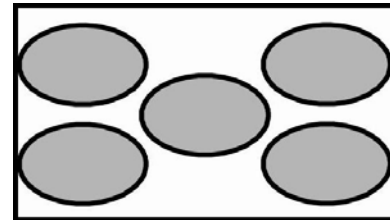

### Panoramic Mode

When watching a standard broadcast or full frame movie in this mode, the 4:3 Aspect Ratio (1.33:1 source) display image is stretched horizontally on the left and right sides to fill the TV screen. The center of the image is not stretched.

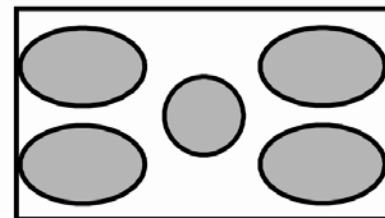

## Chapter 4 Maintenance and Troubleshooting

### Maintenance

#### Important

1. Make sure that the power cable is removed from the socket before cleaning the TV.
2. Do not use volatile solvent (such as toluene, rosin and alcohol) to clean the TV. Such chemicals may damage the housing, screen and remote control, and cause paint to peel.

#### Cleaning the Housing and Remote Control

3. Use a soft cloth for cleaning.
4. If the housing or remote control is seriously contaminated, use a soft cloth moistened with diluted neutral cleaner to clean the display. Wring water out of the cloth before cleaning to prevent water from penetrating into the housing. Wipe the display with a dry cloth after cleaning.

#### Cleaning the Screen

1. Use a soft cloth to gently clean the screen.
2. The screen glass is very fragile. Do not scrape it with any sharp object. Do not press or tap the screen to avoid cracking. If the screen is heavily contaminated, use a soft cloth moistened with diluted neutral cleaner to clean the display. Wring water out of the cloth before cleaning to prevent water from penetrating into the housing. Wipe the display with a dry cloth after cleaning.

## Troubleshooting Guide

If the TV fails to operate, or the performance changes dramatically, check the display in accordance with the following instructions. Remember to check the peripherals to pinpoint the source of the problem. If the display still fails to perform as expected, contact the VIZIO for assistance by calling 1-877-698-4946 or e-mail us at [techsupport@vizio.com](mailto:techsupport@vizio.com).

Problem	Solution
No power.	<p>Make sure the power button is ON (VIZIO Logo glows white).</p> <p>Make sure AC power cord is securely connected to the AC socket.</p> <p>Plug another electrical device (like a radio) to the power outlet to verify that the outlet is supplying power.</p>
No sound.	<p>Press the Volume + (Up) key on the remote control</p> <p>Check to see if the MUTE symbol is displayed in the lower corner of the screen. Press MUTE on the remote so that MUTE disappears from the screen</p> <p>Check your audio settings. If TV input is selected, audio may be set to SAP, or speakers are set to off.</p> <p>If external devices are selected input, check the audio connections.</p>
If the screen is black.	<p>Make sure the power button is ON (VIZIO Logo glows white).</p>



Problem	Solution
	<p>Press the INPUT button on the TV or the Remote. Check the input connections.</p>
<p>Power is ON but no screen image.</p>	<p>Make sure any cable attached to the TV is connected to the correct output from a Set-Top Box, DVD, etc. Adjust brightness, contrast or backlight. Check Input settings.</p>
<p>Wrong or abnormal colors appear.</p>	<p>Check Color and tint settings in Picture Menu. Reset Picture settings. Component Input: If any colors (red, or blue) are missing, check the video cables to make sure they are securely connected. PC Input: If any colors (red, green, or blue) are missing, check the video cable to make sure it is securely connected.</p>
<p>Control buttons do not work.</p>	<p>Press only one button at a time.</p>
<p>Remote Control does not work.</p>	<p>Make sure batteries are inserted correctly Batteries could be weak. Make sure you have selected TV on the remote.</p>
<p>There appears to be image quality issues.</p>	<p>For best image quality, view HD wide screen programs where possible. If HD content is not available view "Standard Definition" from a digital source. Standard, analog TV will always be noticeably inferior to HD because your digital flat panel TV has video that is many times better than old TV's and so you can see interference and deficiencies you did not know you had.</p>
<p>You cannot see a picture.</p>	<p>Make sure that the power cord is plugged into a grounded electrical outlet. Make sure that the power button is turned on. Make sure that the selected input source is connected to a working input source. If your TV is connected to your computer in RGB or HDMI mode, press any key on your keyboard to "wake" your computer.</p>
<p>You see a distorted picture or hear unusual sound.</p>	<p>You may be getting interference from electrical appliances, cars, motorcycles, or fluorescent lights. If you have not mounted it on the wall, try moving your TV to another location to see if this is the cause of the problem.</p>
<p>The picture has abnormal patterns.</p>	<p>Make sure that the input source cable is attached securely and correctly to the back of your TV. Make sure that the video input source is within the range of your TV. Compare the video input source's specifications with your TV specifications.</p>
<p>The display image does not cover the entire screen.</p>	<p>If you are using RGB mode, make sure that H Size and V Position in the On Screen Display (OSD) are set correctly. If you are using TV, AV1, AV2 or Component with 480i input, use the WIDE button on the remote control to scroll through various screen modes.</p>



Problem	Solution
You can see a picture but you cannot hear sound.	Make sure that the volume is not turned down. Make sure that the sound is not muted. Make sure that your audio input source cables are connected securely and correctly.
The TV has pixels that are always dark or colored.	Your LCD HDTV is manufactured using an extremely high level of precision technology, however, sometimes some pixels of your LCD HDTV may not display. Pixel defects within industry specifications are inherent to this type of product and do not constitute a defective product.
You see “noise” or “trash” on the screen.	When your LCD HDTV's digital capabilities exceed a digital broadcast signal, the signal is up-converted (increased) to match your TV's display capabilities. Up-converting can cause noise or trash.
You switch to a different input and the volume changes.	The TV remembers the volume level from the last time you adjusted it. If the sound level is higher or lower from another source, then the loudness will change.
Tips for High-Definition Users.	The LCD HDTV is an ideal platform for viewing High Definition Content. Best Image Quality will be achieved by the HDMI Input, then YPbPr, then RGB. However, due to variances in broadcast practices, it is possible some image distortions can occur.

## Telephone & Technical Support

Products are often returned due to a technical problem rather than a defective product that may result in unnecessary shipping charges billed to you. Our trained support personnel can often resolve the problem over the phone. For more information on warranty service or repair, after the warranty period, please contact our Support Department at the number below.

Customer support and quality service are integral parts of VIZIO's commitment to service excellence.

For technical assistance contact our VIZIO Technical Support Department via email or phone.

Email: [techsupport@vizio.com](mailto:techsupport@vizio.com)

Tel: (877) 698-4946 Fax: (949) 585-9563

Hours of operation: Monday - Friday: 6 am to 9 pm

Saturday – Sunday: 8 am to 4 pm

Please have your VIZIO model number, serial number, and date of purchase available before you call.

**VIZIO**

Address:

39 Tesla

Irvine, CA 92618, USA

Telephone: (949) 428-2525 Fax: (949) 585-9514

Web: [www.vizio.com](http://www.vizio.com)



## Compliance

Caution: Always use a power cable that is properly grounded. Please use the AC cords listed below for each area.

USA	UL
Canada	CSA
Germany	VDE
UK	BASE/BS
Japan	Electric Appliance Control Act

## FCC Class B Radio Interference Statement

NOTE: This equipment has been tested and found to comply with the limits for a Class B digital device, pursuant to Part 15 of the FCC Rules. These limits are designed to provide reasonable protection against harmful interference in a residential installation. This equipment generates, uses and can radiate radio frequency energy, and if not installed and used in accordance with the instructions, may cause harmful interference to radio communications. However, there is no guarantee that interference will not occur in a particular installation. If this equipment does cause harmful interference to radio or television reception, which can be determined by turning the equipment off and on, the user is encouraged to try to correct the interference by one or more of the following measures:

1. Reorient or relocate the receiving antenna.
2. Increase the separation between the equipment and receiver.
3. Connect the equipment into an outlet on a circuit different from that to which the receiver is connected.
4. Consult the dealer or an experienced radio/TV technician for help.

### Notice:

1. The changes or modifications not expressly approved by the party responsible for compliance could void the user's authority to operate the equipment.
2. Shielded interface cables and AC power cord, if any, must be used in order to comply with the emission limits.
3. The manufacturer is not responsible for any radio or TV interference caused by unauthorized modification to this equipment. It is the responsibilities of the user to correct such interference.



## Chapter 5 Miscellaneous Information

### Specifications for VT420M

Specifications	
Panel	42" Diagonal (42.02" Diagonal viewing), 16:9 Aspect Ratio
Resolution	1920 x 1080 pixels
Pixel (Dot) Pitch	0.4845mm x 0.4845mm
Display Compatibility	1080P (Full HDTV)
Colors	1.06 Billion
Brightness	450 cd/m <sup>2</sup> (typical)
Contrast	4000 :1 (typical)
Response Time	5ms (typical)
Viewing Angle	Horizontal and Vertical 176° (typical)
Inputs	1x Coaxial RF (ATSC/QAM/NTSC), 4x HDMI™** with HDCP 2x Component YPbPr plus Stereo Audio, 1x RGB PC plus Stereo Audio (1/8" stereo jack), 1x Composite Video plus Stereo Audio, 1x S-Video plus Stereo Audio, 1xUSB
Outputs	1x Optical Audio (SPDIF Optical), 1x Headphone
Features	FULL HD, PIP, POP, Noise Reduction, CC, V-Chip 2.0, 3D Comb Filter, Freeze, Support Motion Enhancement and Motion Correction, Picture Enhancement, MPEG-2 Decoding via DTV input, NTSC Video decoding via Video (AV, S-Video or Component), Progressive Scan Video via HDMI™**, Component or RGB, HDTV via HDMI™**, Component or RGB (Set-Top Box required), Computer 640x480, 800x600, 1024 x 768, 1920x1080 via RGB or 1920x1080 via HDMI, Built-in SRS (TruSurroundHD™/TruVolume™) Audio, Supports 1080P (Full HDTV) , 1080i (HDTV) , 720P (HDTV) , 480P (EDTV) and 480i (SDTV) video signals. 1080P FHDTV, HDMI V.1.3, 120 Hz Motion Estimation & Motion Compensation, Dolby Digital Decoding, SRS TruSurround HD and SRS TruVolume sound enhancement, USB 1080P Digital (MP3 music and JPEG photo files) Media Player
Speakers	2 x Speaker enclosures (Left and Right), 10Watts per enclosure
Panel Life	50,000 hours to half the original brightness
Power	
Input	IEC Connector for direct power line connection
Voltage Range	100 ~ 240Vac at 50/60Hz
Power Consumption	176W (Avg), <1W Standby
Environmental Conditions	
Operating	Temperature: 5°C~35°C, Relative Humidity: 20~80%, Altitude: 0~14,000 ft
Non-Operating	Temperature: -20°C~50°C, Relative Humidity: 10~90%, Altitude: 0~40,000 ft
Dimensions	40.3" W x 27.8" H x 11.4" D with stand; 40.3" W x 26.1" H x 4" D without stand
Net Weight	44.1lbs with stand, 37.4lbs without stand
Gross Weight	51.8lbs
Certifications	CSA, CSA-US, FCC Class B, Energy Star 3.0

\*Product specifications may change without notice or obligation.



## Specifications for VT470M

Specifications	
Panel	47" Diagonal, 16:9 Aspect Ratio
Resolution	1920 x 1080 pixels
Pixel (Dot) Pitch	0.5415mm x 0.5415mm
Display Compatibility	1080P (Full HDTV)
Colors	1.06 Billion
Brightness	500 cd/m <sup>2</sup> (typical)
Contrast	4000 :1 (typical)
Response Time	5ms (typical)
Viewing Angle	Horizontal and Vertical 176° (typical)
Inputs	1x Coaxial RF (ATSC/QAM/NTSC), 4x HDMI™** with HDCP 2x Component YPbPr plus Stereo Audio, 1x RGB PC plus Stereo Audio (1/8" stereo jack), 1x Composite Video plus Stereo Audio, 1x S-Video plus Stereo Audio, 1xUSB
Outputs	1x Optical Audio (SPDIF Optical), 1x Headphone
Features	FULL HD, PIP, POP, Noise Reduction, CC, V-Chip 2.0, 3D Comb Filter, Freeze, Support Motion Enhancement and Motion Correction, Picture Enhancement, MPEG-2 Decoding via DTV input, NTSC Video decoding via Video (AV, S-Video or Component), Progressive Scan Video via HDMI™**, Component or RGB, HDTV via HDMI™**, Component or RGB (Set-Top Box required), Computer 640x480, 800x600, 1024 x 768, 1920x1080 via RGB or 1920x1080 via HDMI, Built-in SRS (TruSurroundHD™/TruVolume™) Audio, Supports 1080P (Full HDTV) , 1080i (HDTV) , 720P (HDTV) , 480P (EDTV) and 480i (SDTV) video signals. 1080P FHDTV, HDMI V.1.3, 120 Hz Motion Estimation & Motion Compensation, Dolby Digital Decoding, SRS TruSurround HD and SRS TruVolume sound enhancement, USB 1080P Digital (MP3 music and JPEG photo files) Media Player
Speakers	2 x Speaker enclosures (Left and Right), 12Watts per enclosure
Panel Life	50,000 hours to half the original brightness
Power	
Input	IEC Connector for direct power line connection
Voltage Range	100 ~ 240Vac at 50/60Hz
Power Consumption	215W (Avg), <1W Standby
Environmental Conditions	
Operating	Temperature: 5°C~35°C, Relative Humidity: 20~80%, Altitude: 0~14,000 ft
Non-Operating	Temperature: -20°C~50°C, Relative Humidity: 10~90%, Altitude: 0~40,000 ft
Dimensions	44.9" W x 30.4" H x 11.4" D with stand; 44.9" W x 29.1" H x 4.6" D without stand
Net Weight	52.9lbs with stand, 48.5lbs without stand
Gross Weight	65.9lbs
Certifications	CSA, CSA-US, FCC Class B, Energy Star 3.0

\*Product specifications may change without notice or obligation.





## Glossary – Standard Definitions

- Analog TV:** Today's TV system using radio frequency waves to transmit and display pictures and sound.
- Aspect Ratio (4x3):** Traditional TV "aspect ratio", that is, the screen width as compared to its height. For example, a "32 inch TV screen" would be 25 inches wide and 19 inches tall.
- Aspect Ratio (16x9):** "Wide screen TV" aspect ratio which is more like a movie screen than a traditional TV. For example, a "32 inch TV screen" would be 28 inches wide and 16 inches tall.
- Digital TV (DTV):** Television delivered and displayed using radio frequency waves that contain information that is digitally encoded for improved quality and efficiency.
- Enhanced Definition TV (EDTV):** A better digital television transmission than SDTV with at least 480P, in a 16x9 or 4x3 display and Dolby digital surround sound. 480P is the quality used by most DVD players. EDTV provides 300-400,000 pixels.
- HDTV Monitor (sometimes called HDTV Ready):** A set that can display HDTV programming if you have a separate HDTV tuner, HD Cable Set-Top Box or HD Satellite Set-Top-Box Receiver.
- HDTV Tuner (also decoder, receiver, set-top box):** A device capable of receiving and outputting HDTV signals for display. It may be stand-alone or integrated in the set.
- High-Definition Television (HDTV):** The best quality picture, wide screen (16x9) display with at least 720 progressively scanned lines (720P) or 1080 interlaced lines (1080i) and Dolby digital surround sound. HDTV provides 900,000-2.1 million pixels.
- Integrated HDTV:** An HDTV that has the digital tuner built into the set. It does not need a separate set-top box to receive over-the-air DTV signals.
- Interlace Scan:** A way to scan vertical lines onto a TV picture by scanning all the odd lines first, then filling the in the even lines (this happens instantaneously).
- Plug-and-Play or Digital Cable Ready:** A DTV or other device for digital cable consumers that plugs directly into the cable jack and does not require a separate set-top box. Plug-and-Play TV owners must obtain a CableCARD from their cable company in order to view scrambled programming services.
- Progressive Scan:** A way to scan vertical lines onto a TV picture by scanning all the lines consecutively (progressively).
- Standard Definition TV (SDTV):** Basic digital television transmission that may be displayed with fewer than 480 progressively scanned lines (480P) in 16 x 9 or 4 x 3 format. 480 interlaced (480i) is the quality of today's analog TV system.

Source: Buying a Digital Television, CEA, HDTV Guide, 2005

**Note:** The Federal Communications Commission (FCC), the Consumer Electronics Association (CEA) and the Consumer Electronics Retailers Coalition (CERC) have made a new tip sheet available for digital television (DTV) retailers to reproduce and distribute to consumers on the sales floor. The file may be downloaded online at [www.dtv.gov](http://www.dtv.gov). While you're there, check out the other useful information in the FCC is making available to consumers interested in learning more about the analog to digital transition.



## Limited Product Warranty

VIZIO provides a "ONE-YEAR LIMITED WARRANTY" against manufacturing defects in materials and workmanship to the original purchaser of a new VIZIO display purchased from an authorized VIZIO U.S. reseller and used in the fifty (50) United States or Puerto Rico.

### VIZIO's Responsibility

VIZIO displays purchased new from an authorized VIZIO U.S. reseller and that are used in the fifty (50) United States or Puerto Rico are warranted to be free from manufacturing defects in materials and workmanship for one (1) year from the date of the original retail purchase. If the display fails to conform to this limited warranty, VIZIO will, at its option and sole discretion, repair or replace the display.

### Labor

During the one-year limited warranty period, VIZIO will provide, when needed, service labor to repair a manufacturing defect. Repairs required on displays which are thirty (30) inches and larger generally will be made "on-site" where the display is installed. The determination for performing the on-site repair is dependent upon the manufacturing defect and is at VIZIO's option and sole discretion. Repairs required on displays which are less than thirty (30) inches generally will be performed at a VIZIO service center.

### Parts

Repairs may be made with new or recertified parts, or the entire unit may be replaced with a new or recertified unit, at VIZIO's option and sole discretion. Replacement parts or replacement units provided under this limited warranty are warranted for the remaining portion of the original warranty period, or for ninety (90) days from warranty service or replacement, whichever is later.

### How to Obtain Warranty Service

To obtain warranty service, contact VIZIO Technical Support via email at [techsupport@vizio.com](mailto:techsupport@vizio.com), via phone at 877-MYVIZIO (877-698-4946), or via postal mail at VIZIO Technical Support, 39 Tesla, Irvine, CA 92618. You must provide the model, serial number, and date of purchase. VIZIO Technical Support is available from 6:00AM to 9:00PM Pacific Time, Monday through Friday, and 8:00AM to 4:00PM Pacific Time, Saturday and Sunday. Please note that holiday hours may vary. For up to date information, please visit [www.VIZIO.com](http://www.VIZIO.com).

VIZIO reserves the right to assess all warranty claims and to determine if defects or damages are covered by this limited warranty. In case of a claim that is not covered by this warranty, you will be contacted to determine whether VIZIO should repair the damage for a fee or whether the product should be returned to you as received by the service technician or service center.

Parts and service labor that are VIZIO's responsibility under this limited warranty will be provided without charge. All other service is at the customer's expense. VIZIO reserves the right to charge the customer for any service call for anything not covered by this limited warranty. Before you ask for warranty service, please review your User Manual. You may avoid a service call and a service charge.

### **PLEASE DO NOT RETURN YOUR UNIT TO VIZIO WITHOUT PRIOR AUTHORIZATION.**

### Not Covered

This limited warranty does not cover the following: cosmetic defects; damage, malfunctions or failures resulting from shipping or transit, improper or faulty installation, abuse, operation contrary to furnished instructions, operation on incorrect power supplies, products not supplied by VIZIO, modification, alteration, improper servicing or tampering; damage from fire, water, lightning, power surges, abnormal environmental conditions or other acts of nature; normal wear and tear; unsatisfactory visual or audio performance not caused by a manufacturing defect; or displays with a missing or unreadable serial number. Operation of the display for commercial purposes or in applications or uses for which the display is not intended is not covered by this limited warranty. "Image Sticking", caused by static images on the screen for extended periods and or excessive brightness and contrast levels, is not covered by this limited warranty. Installation, removal, transportation and reinstallation of a display, and routine maintenance and cleaning, are not covered by this limited warranty.

THERE ARE NO EXPRESS WARRANTIES OTHER THAN THOSE LISTED OR DESCRIBED ABOVE.



ANY IMPLIED WARRANTIES, INCLUDING ANY IMPLIED WARRANTY OF MERCHANTABILITY AND FITNESS FOR A PARTICULAR PURPOSE, SHALL BE LIMITED IN DURATION TO THE PERIOD OF TIME SET FORTH ABOVE. VIZIO'S TOTAL LIABILITY FOR ANY AND ALL LOSSES AND DAMAGES RESULTING FROM ANY CAUSE WHATSOEVER, INCLUDING VIZIO'S NEGLIGENCE, ALLEGED DAMAGE, OR DEFECTIVE GOODS, WHETHER SUCH DEFECTS ARE DISCOVERABLE OR LATENT, SHALL IN NO EVENT EXCEED THE PURCHASE PRICE OF THE DISPLAY. VIZIO SHALL NOT BE RESPONSIBLE FOR LOSS OF USE, COMMERCIAL LOSS, LOST REVENUE OR LOST PROFITS, OR OTHER INCIDENTAL OR CONSEQUENTIAL DAMAGES. SOME STATES DO NOT ALLOW LIMITATIONS ON HOW LONG AN IMPLIED WARRANTY LASTS OR THE EXCLUSION OR LIMITATION OF INCIDENTAL OR CONSEQUENTIAL DAMAGES, SO THE ABOVE LIMITATIONS OR EXCLUSIONS MAY NOT APPLY TO YOU.

This warranty gives you specific legal rights, and you may also have other rights, which vary from state to state. This is the only warranty applicable; no one is authorized to extend or modify it or to grant any other warranty on VIZIO's behalf.

### Owner's Responsibility

To ensure warranty service, keep the dated bill or sales receipt as evidence of the purchase date and location. This limited warranty applies only to original purchaser and is non-transferable.

**Note:** Warranty service conditions are subject to change. For the latest Warranty Terms and Conditions and additional information regarding VIZIO's Limited Product Warranty, please see complete details online at [www.VIZIO.com](http://www.VIZIO.com).

## VIZIO Return Policy

VIZIO's return policy allows for products purchased directly from VIZIO to be returned by the original purchaser during the initial thirty (30) day period following the date of purchase. A VIZIO return authorization number must first be obtained as provided below. The refund will be the purchase price actually paid by the purchaser less a ten percent (10%) restocking fee per each item returned. Shipping and handling are not refundable.

The return authorization number must first be obtained from VIZIO's Customer Service by emailing [CustomerSupport@VIZIO.com](mailto:CustomerSupport@VIZIO.com) or by calling 949-428-2525, 6:00AM to 9:00PM Pacific Time, Monday through Friday, and 8:00AM to 4:00PM Pacific Time, Saturday and Sunday. Please note that holiday hours may vary. For up to date information, please visit [www.VIZIO.com](http://www.VIZIO.com).

Products must be returned to the address specified by VIZIO Customer Service and must be shipped in the original packaging, with freight prepaid to VIZIO, and must be received in new and unused condition. The return authorization number must be included in the packaging. VIZIO reserves the right to assess fees for any damaged or missing parts in addition to the ten percent (10%) restocking fee.

Return authorization numbers are valid for only fifteen (15) days from issuance. The customer is responsible for and must prepay all shipping charges and shall assume all risk of loss or damage to the product while in transit to VIZIO. If the product is returned to VIZIO (i) without a VIZIO return authorization number, and/or (ii) beyond the fifteen (15) day period, and/or (iii) without proper packaging, VIZIO retains the right to refuse delivery of such return or may return the unit to the customer at the customer's expense and with no refund issued. This return policy does not apply to defective products. Please read VIZIO's Limited Product Warranty for warranty terms and conditions.

### On-Site Warranty Repair Procedure

**On-Site Warranty Repair generally is performed on repairable displays which are 30 inches and larger.**

If VIZIO Technical Support determines that a problem with a display unit may be within the terms and conditions of the VIZIO Limited Product Warranty and that an on-site repair may be performed, the customer will be provided with an on-site repair authorization number and on-site repair instructions. The determination for performing the on-site repair may be dependent upon the manufacturing defect and is at VIZIO's option and sole discretion. Proof of purchase is required to confirm the product is within the one-year limited warranty period and meets the terms and conditions of the VIZIO Limited Product Warranty.



On-site repair service is requested through VIZIO's third-party service provider. After VIZIO provides the customer with the on-site repair (OSR) authorization number, the third-party service provider will contact the customer and will schedule the repair at the customer's location. The total approximate time for the repair process, which includes the repair diagnosis, dispatching the technician, shipping the replacement part(s), and arranging the appointment with the customer, is completed within approximately 3 to 5 business days, pending availability of these factors.

If it is determined the product cannot be repaired on-site, the customer will be required to ship the unit to VIZIO's service center, per the below warranty replacement procedure.

VIZIO is not responsible for the de-installation or re-installation of the product. However, some standard installation may be performed during the on-site repair, at VIZIO's option and sole discretion. Please read VIZIO's Limited Product Warranty for warranty terms and conditions.

### **Warranty Replacement Procedure**

**Warranty Replacement generally is performed on displays which are determined to be economically unrepairable.**

If VIZIO Technical Support determines that a problem with a display unit may be within the terms and conditions of the VIZIO Limited Product Warranty and that a repair is not economically possible, based on certain manufacturing defects in materials and/or workmanship, and/or at VIZIO's option and sole discretion, the customer will be provided with a return authorization number and replacement instructions. Proof of purchase is required to confirm the product is within the one-year limited warranty period and meets the terms and conditions of the VIZIO Limited Product Warranty.

For displays forty-two inches (42") and larger, VIZIO will generally cover the transportation charges to perform an on-site swap of the original unit with the replacement unit. For displays under forty-two inches (42"), the customer is responsible for the transportation charges to VIZIO's service center. VIZIO will be responsible for the return transportation charges from the service center to the customer. Please read VIZIO's Limited Product Warranty for warranty terms and conditions.

### **Mail-In Warranty Repair Procedure**

**Mail-In Warranty Repair generally is performed on displays which are smaller than 30 inches.**

If VIZIO Technical Support determines that a problem with a display unit may be within the terms and conditions of the VIZIO Limited Product Warranty and that a mail-in repair may be performed, the customer will be provided with a return authorization number and mail-in repair instructions. Proof of purchase is required to confirm the product is within the one-year limited warranty period and meets the terms and conditions of the VIZIO Limited Product Warranty.

The customer will be provided with instructions for packing and shipping the unit to the VIZIO service center. The original carton box and packing material, or an equivalent as designated by VIZIO, must be utilized. The cost of shipping to VIZIO's service center is at the customer's expense. After the product is repaired and tested, the VIZIO service center will ship the unit back to the customer at VIZIO's expense. VIZIO is not responsible for the de-installation or re-installation of the product. Please read VIZIO's Limited Product Warranty for warranty terms and conditions.

**PLEASE DO NOT RETURN YOUR UNIT TO VIZIO WITHOUT PRIOR AUTHORIZATION.**



## Index

### A

AC IN jack, 14  
 access code  
   changing, 48  
 Accessories, 8  
 Adjustments  
   Selecting the Screen Size, 58  
   Volume, 12, 52  
 antenna  
   setting as TV signal source, 41  
 antenna jack, 13  
 audio settings  
   adjusting, 44  
   speakers, 44  
   surround mode, 44  
 AV In jack, 13

### B

backlight  
   adjusting, 43  
 blocking channels, 45  
 brightness  
   adjusting, 43

### C

cable  
   setting as TV signal source, 41  
 CC (Closed Caption)  
   selecting, 49  
 channel block  
   selecting, 45  
 channels  
   deleting, 41  
   searching for, 41  
 Cleaning your VIZIO TV, 52  
 Co-axial RF  
   Connecting for DTV, 21  
   Connecting for TV, 22  
 color  
   adjusting, 43  
 color temperature  
   adjusting, 43  
 Component  
   Connecting your Cable Box, 20  
   Connecting your DVD Player, 25  
   Connecting your Satellite Box, 20  
 component jacks, 13  
 Composite (AV)  
   Connecting your DVD Player, 26, 27  
   Connecting your VCR, 28  
   Connecting your Video Camera, 28  
 contrast  
   adjusting, 43  
 Controls  
   Front Panel, 12  
   Side Panel, 12

### D

daylight saving  
   selecting, 41, 49  
 DTV  
   jack, 13  
 DTV Special Features  
   PIP, 50  
 DVI  
   Connecting your Cable Box, 19  
   Connecting your DVD Player, 24  
   Connecting your Satellite Box, 19

### F

FCC Bulletin for New TV Owners, 5

### G

Glossary, 58

### H

HDMI  
   Connecting your Cable Box, 18  
   Connecting your DVD Player, 23  
   Connecting your Satellite Box, 18  
 HDMI 1 jack, 13  
 HDMI 2 jack, 13

### I

Inputs  
   Antenna, 4  
   Connectors, 17  
 Installation  
   Preparation, 8  
   Wall Mounting, 8

### L

language  
   selecting OSD, 49

### M

movie ratings  
   blocking, 47  
 MTS  
   Stereo, SAP, Mono, 41

### N

Normal aspect ratio, 51



## O

- On-Screen Display, 37
  - selecting language, 49

## OSD, 37

- Brightness Adjustment, 56, 57
- Color Adjustment, 17
- Contrast Adjustment, 56, 57
- selecting language, 49

## Outputs

- Using an external Receiver/Amp, 29

## P

### parental control

- access code edit, 48
- channel block, 45
- movie rating, 47
- options, 45

### password

- changing, 48

### picture settings, 42, 43

- backlight, 43
- brightness, 43
- color, 43
- color temperature, 43
- contrast, 43
- sharpness, 43
- tint, 43

### power connector, 14

## R

### rear jacks

- AC IN, 14
- antenna, 13
- AV In, 13
- component, 13
- HDMI 1, 13
- HDMI 2, 13
- power connector, 14
- RGB PC, 13

### Remote

- Layout, 15

### remote control

- installing batteries, 16
- range, 16
- safety, 16

### Remote Control

- Using your Cable or Satellite Remote to Operate your VIZIO TV, 16

### resetting

- all settings, 49

### RGB

- Connecting your PC, 30

### RGB PC jacks, 13

## S

### safety instructions, 2

### SAP

- selecting, 41

### Screen Size explanation, 51

### setup menu

- closed caption, 49
- language, 49
- options, 49
- reset all setting, 49
- sleep timer, 49

### sharpness

- adjusting, 43

### sleep timer

- setting, 49

### speakers

- turning off and on, 44

### surround mode

- turning off and on, 44

### S-Video

- Connecting your DVD Player, 26, 27

## T

### Technical Specifications, 56, 57

### time zone

- selecting, 41

### tint

- adjusting, 43

### Troubleshooting Guide, 52

### tuner mode

- selecting, 41

### TV

#### settings

- adjusting, 41

### TV signal source

- selecting, 41

### TV Special Features

- PIP, 50

### TV tuner settings

- adjusting, 41
- auto search, 41
- daylight saving, 41
- deleting channels, 41
- MTS, 41
- searching for channels, 41
- skipping channels, 41
- time zone, 41
- tuner mode, 41

## W

### Warranty, 59

### Watching TV

- Basic connections, 32
- First Startup, 32
- Getting your Programs, 35, 36



